

# SAMSUNG

## ECO HEATING SYSTEM

### OUTDOOR UNIT

Model : (Split)  
AE040RXEDEG  
AE060RXEDEG  
AE090RXEDEG  
AE090RXEDGG

(Mono)  
AE050RXYDEG  
AE080RXYDEG  
AE120RXYDEG  
AE160RXYDEG  
AE080RXYDGG  
AE120RXYDGG  
AE160RXYDGG

### TANK INTEGRATED HYDRO UNIT

(Split)  
AE200RNWSEG  
AE260RNWSEG  
AE260RNWSGG

(Mono)  
AE200RNWMEG  
AE260RNWMEG  
AE260RNWMGG

# SERVICE *Manual*

## ECO HEATING SYSTEM



## CONTENTS

1. Precautions
2. General Overview
3. Disassembly and Reassembly
4. Troubleshooting
5. PCB Diagram
6. Wiring Diagram
7. Reference Sheet

# Contents

<b>1. Precautions.....</b>	<b>3</b>
1-1 Precautions for the Service.....	3
1-2 Precautions related to static electricity and PL.....	3
1-3 Precautions for the Safety.....	4
1-4 Precautions for handling a system containing refrigerants.....	5
1-5 Precautions for the brazing.....	5
1-6 Precautions for charging refrigerants.....	5
<b>2. General Overview.....</b>	<b>6</b>
2-1 Features of the System.....	6
2-2 Product Specifications.....	8
2-3 Specifications of optional items.....	16
<b>3. Disassembly and Reassembly.....</b>	<b>18</b>
3-1 Tank Integrated Hydro Unit.....	19
3-2 Outdoor Unit.....	24
<b>4. Troubleshooting.....</b>	<b>74</b>
4-1 Wired remote controller.....	74
4-2 Troubleshooting by symptoms.....	77
4-3 Hydro Unit.....	78
4-4 Items to check before diagnostics.....	84
4-5 Troubleshooting by symptoms.....	85
<b>5. PCB Diagram.....</b>	<b>100</b>
5-1 Tank Integrated Hydro Unit.....	100
5-2 Outdoor Unit.....	102

# Contents

<b>6. Wiring Diagram.....</b>	<b>113</b>
6-1 Hydro unit.....	113
6-2 Outdoor Unit.....	115
<b>7. Reference Sheet.....</b>	<b>118</b>
7-1 Index for Model Name.....	118
7-2 Tank intergrated hydro unit(SPLIT).....	119
7-3 Tank intergrated hydro unit(MONO).....	120
7-4 FSV Data check and update using S-NET Pro2.....	121
7-5 EHS FSV Values Import and Export.....	122

---

# 1. Precautions

---

## 1-1 Precautions for the Service

---

- **Use the standard parts when replacing the electric parts.**
  - Confirm the model name, rated voltage, rated current of the electric parts.
- **When repairing the equipment, connection of the harness parts must be firm and solid.**
  - A loose connection may cause noise or other malfunction.
- **When assembling and disassembling the equipment while it is laid down, lay it on soft cloth.**
  - Otherwise it may scratch the back of the exterior of the product.
- **Remove dust or dirt completely from the housing block, wiring block and service parts during repair.**
  - This helps prevent the danger of fire caused by tracking or short circuit.
- **Fasten the valve caps of service valves and charging valves of outdoor unit as much as possible using adjustable wrenches.**
- **Check the status of the components' assembly after repair service.**
  - The status must be the same as before the repair service.

## 1-2 Precautions related to static electricity and PL

---

- **The PCB power supply block is susceptible to static electricity. Therefore, care must be taken during repair or measuring while the power is on.**
  - Wear insulation gloves for PCB repair or measuring.
- **Check whether the installation location is at least two meters away from other electronic products such as TV, video, or audio.**
  - Otherwise, the video quality might be degraded or noise might be generated.
- **Do not let end users repair the products themselves.**
  - Unauthorized disassembly might cause electric shock or fire.



## 1-3 Precautions for the Safety

---

- **Do not pull any electric wires and do not touch an auxiliary power switch with a wet hand.**
  - There is a danger of electric shock or fire.
- **In case any wire or power plug has been damaged, replace it to eliminate any possible danger.**
- **Do not bend the power cord by force and do not put any heavy object on the power cord.**
  - There is a danger of electric shock or fire.
- **Do not use multi socket.**
  - There is a danger of electric shock or fire.
- **Ground the product if necessary.**
  - Be sure to ground the product if there is any danger of electric leakage due to water or moisture.
- **Be sure to turn off the auxiliary power switch or pull out the power plug during replacement or repair of electric parts.**
  - There is a danger of electric shock.
- **The installation must be done by the manufacturer or its service agent or a similar qualified person in order to avoid a hazard.**
  - Installation by an unqualified person may cause a water leakage, electric shock or fire and so on.
- **The electric work must be done by service agent or similarly qualified persons according to national wiring regulations and use only rated cable.**
  - If the capacity of the power cable is insufficient or electric work is not properly completed, electric shock or fire may occur.
- **Use only rated parts and tools.**
  - If you don't use the rated parts and tools, it can cause trouble with the air conditioner and bring about injury.
- **If any gas or impurities except R-32 refrigerant come into the refrigerant pipe, serious problem may occur and it may cause injury.**
- **Leak test must be done using only Nitrogen(NO<sub>2</sub>)gas.**

- R-32 refrigerant is used for EHS.
  - When using R-32, moisture or foreign substances may affect to the capacity and reliability of the product. Safety precautions must be taken when installing the refrigerant pipe.
  - The design pressure of the unit is 4.6MPa. Select appropriate material and thickness according to the regulations.

## 1-4 Precautions for handling a system containing refrigerants

---

All system containing refrigerants shall be removed under regional regulations prior to the disposal to prevent the potential health and environmental consequences.

- **Harmful for human body**
  - When emitted liquid refrigerant contacts human body, contacted area may get frostbite, blister or become numb.
  - If refrigerant leaks in airtight area, lack of oxygen may cause suffocation. When refrigerant is heated, it may generate harmful gas.
- **Precautions for handling container**
  - Do not apply shock or heat to the refrigerant container.

## 1-5 Precautions for the brazing

---

- **Clear any dangerous or inflammable materials in surrounding environment.**
- **Make sure to empty the remaining refrigerant in the product or pipe before brazing.**
  - Brazing with the refrigerant still remaining in the product or pipe may cause poor result and generate harmful gas. Furthermore, pressure of the refrigerant may increase and cause damage to the leaking part. This may lead harmful refrigerant and oil to spurt out which can be dangerous for service personnel.
- **Use nitrogen gas to get rid of the oxide forming during brazing.**
  - Using other type of gas may cause damage to the product or the exterior.

## 1-6 Precautions for charging refrigerants

---

- **Add quantity of the refrigerant using a scale and perform a test operation with S-net.**
  - Product performance may decrease if you add excessive amount of refrigerant.
- **Do not charge refrigerants while heating the container up.**
  - The container may get damaged by the heat and result in explosions.
- **Do not operate the product without pressure switch(for product protection) and sensor.**
  - If there are any internal blockage, high refrigerant pressure increase may damage the product or exterior.

## 2. General Overview

### 2-1 Features of the System

#### POWER SAVING

**EHS(Eco Heating System)** considers the trend in air conditioner use. It optimizes the energy efficiency of loads ranging from partial to full. It achieves an excellent energy effect for the users of the air conditioner.

#### Samsung patented compressor

Samsung has been researching and developing compressors since the 70's. It has developed power saving compressors for more than thirty years.

The **EHS(Eco Heating System)** compressor adopts a double-rotor BLDC compressor with permanent magnets made by Samsung. Electricity for the compressor rotor is obtained from a neodymium-iron-boron permanent magnetic material (boron magnet can attract iron material weighing 1000 times its own weight.) It strengthens the rotary moment of the compressor to maximize the entire efficiency of the compressor.

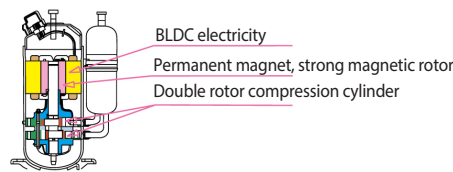

**SAMSUNG's** double-rotor compressor has the upper and lower rotors designed symmetrically. The double rotor in symmetry can remove vibrations caused by the eccentric design of the cylinder.

2 rotors balancing the rotary moment

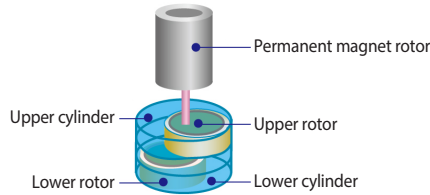
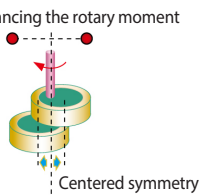

#### High efficiency heat exchanger

**EHS(Eco Heating System)** uses new multiple-teeth screw pipes with a diameter of 8 mm to improve the heat exchangeability of the pipe by **30.8%**.

The water-friendly aluminum foil in the heat exchanger uses the G-fin patent design to improve the efficiency of heat exchange by **13%**.

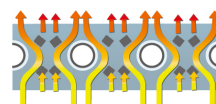

#### DC fan electricity

The **EHS(Eco Heating System)** outdoor machine uses DC fan electricity. The rotational speed of electricity is 100 RPM to 1050 RPM with step-free control. The electrical efficiency is improved by about **33%** compared to AC electricity.

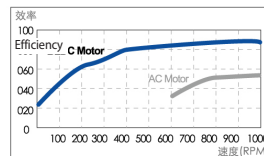
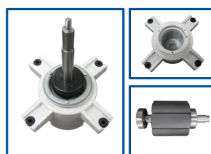

## 2-1-1 Key features of the EHS(SPLIT)

- **Integrated Heating & Cooling system**

Plate Heat exchanger is an integral part in heating & cooling system. For user's convenience, PHE is integrated into the system. This concept will help space saving and lower costs for pipe line reduction.

- **Running Costs-Reduction of Up to 33.5%**

Samsung EHS, known for its world class efficiency (12kW floor heating system with 4.63), can reduce 33.5% of your running costs as compared to a gas boiler.

- **High Performance at Low Temperature**

Samsung EHS is made up of an inverter compressor optimally operated according to the outdoor temperature, offering heating performance of 90% at -10°C and reliable frost protection at -25°C.

- **Heat pump operating range of DHW : -25 ~ 35 °C**

At the temperature -25 °C ~ -20 °C, operation is available but capacity cannot be guaranteed.

## 2-2 Product Specifications

### 2-2-1 Outdoor Unit (Split)

Model Name		Indoor Unit		AE200RNWSEG	AE200RNWSEG	AE200RNWSEG	AE260RNWSSGG	AE260RNWSEG	AE260RNWSEG	AE260RNWSEG							
		Outdoor Unit		AE040RXEDEG	AE060RXEDEG	AE090RXEDEG	AE090RXEDGG	AE040RXEDEG	AE060RXEDEG	AE090RXEDEG							
Outdoor Unit & Tank Hydro Unit Figure																	
System	Mode			Heat Pump (A2W)		Heat Pump (A2W)		Heat Pump (A2W)		Heat Pump (A2W)		Heat Pump (A2W)		Heat Pump (A2W)		Heat Pump (A2W)	
	A2W Condition #1. (A7/W35) *1	Nominal Capacity	Heating	W	4,400	6,000	9,000	9,000	4,400	6,000	9,000	4,400	6,000	9,000	4,400	6,000	9,000
			Btu/h	15,000	20,500	30,700	30,700	15,000	20,500	30,700	15,000	20,500	30,700	15,000	20,500	30,700	
		Cooling	W	5,000	6,500	8,700	8,700	5,000	6,500	8,700	5,000	6,500	8,700	5,000	6,500	8,700	
			Btu/h	17,100	22,200	29,700	29,700	17,100	22,200	29,700	17,100	22,200	29,700	17,100	22,200	29,700	
		Power Input (Nominal)	Heating	W	846	1,220	1,870	1,870	846	1,220	1,870	846	1,220	1,870	846	1,220	1,870
			Cooling	W	1,090	1,470	2,110	2,110	1,090	1,470	2,110	1,090	1,470	2,110	1,090	1,470	2,110
		Current Input (Nominal)	Heating	A	3.9	5.6	8.6	8.6	3.9	5.6	8.6	3.9	5.6	8.6	3.9	5.6	8.6
			Cooling	A	4.9	6.7	9.7	9.7	4.9	6.7	9.7	4.9	6.7	9.7	4.9	6.7	9.7
		COP (Nominal Heating)		W/W	5.20	4.92	4.81	4.81	5.20	4.92	4.81	5.20	4.92	4.81	5.20	4.92	4.81
		EER (Nominal Cooling)		W/W	4.59	4.42	4.12	4.12	4.59	4.42	4.12	4.59	4.42	4.12	4.59	4.42	4.12
	PdesignH (LWT 35°C)		W	5,000	6,000	8,500	8,500	5,000	6,000	8,500	5,000	6,000	8,500	5,000	6,000	8,500	
	SCOP (35°C)		W/W	4.58	4.58	4.45	4.45	4.58	4.58	4.45	4.58	4.58	4.45	4.58	4.58	4.45	
	SEER *2		W/W	4.40	4.73	5.09	5.09	4.40	4.73	5.09	4.40	4.73	5.09	4.40	4.73	5.09	
	A7/W45	Capacity	Heating	W	4,200	5,600	8,600	8,600	4,200	5,600	8,600	4,200	5,600	8,600	4,200	5,600	8,600
		COP	W/W	3.85	3.71	3.69	3.69	3.85	3.71	3.69	3.85	3.71	3.69	3.85	3.71	3.69	
	A7/W55	Capacity	Heating	W	3,900	5,200	8,000	8,000	3,900	5,200	8,000	3,900	5,200	8,000	3,900	5,200	8,000
		COP	W/W	2.95	2.87	2.93	2.93	2.95	2.87	2.93	2.95	2.87	2.93	2.95	2.87	2.93	
	A2/W35	Capacity	Heating	W	4200	5200	7700	7700	4200	5200	7700	4200	5200	7700	4200	5200	7700
		COP	W/W	3.82	3.51	3.41	3.41	3.82	3.51	3.41	3.82	3.51	3.41	3.82	3.51	3.41	
	A-7/W35	Capacity	Heating	W	4600	5500	7900	7900	4600	5500	7900	4600	5500	7900	4600	5500	7900
		COP	W/W	2.97	2.75	2.72	2.72	2.97	2.75	2.72	2.97	2.75	2.72	2.97	2.75	2.72	
	Field Wiring	Hydro Unit	MCA	A	22.7	22.7	22.7	3Φ 8.7 / 1Φ 14.0	22.7	22.7	22.7	22.7	22.7	22.7	22.7	22.7	
			Max Current	A	22.7	22.7	22.7	3Φ 8.7 / 1Φ 14.0	22.7	22.7	22.7	22.7	22.7	22.7	22.7		
			MFA	A	28.4	28.4	28.4	3Φ 10.9 / 1Φ 17.5	28.4	28.4	28.4	28.4	28.4	28.4	28.4		
		Outdoor Unit	MCA	A	16.0	16.0	22.0	10.0	16.0	16.0	16.0	16.0	16.0	16.0	16.0		
			Max Current	A	16.0	16.0	22.0	16.1	16.0	16.0	16.0	16.0	16.0	16.0	16.0		
			MFA	A	20.0	20.0	27.5	16.1	20.0	20.0	20.0	20.0	20.0	20.0	20.0		
	Water Connections	Water Flow Rate (Std)[H/C]		LPM	12.7/14.4	17.3/18.8	26/25.1	26/25.1	12.7/14.4	17.3/18.8	26/25.1	12.7/14.4	17.3/18.8	26/25.1	12.7/14.4	17.3/18.8	26/25.1
		Water Pressure (Max)		bar	3	3	3	3	3	3	3	3	3	3	3	3	3
		Water Pipe	Inlet	Φ, mm	ø28	ø28	ø28	ø28	ø28	ø28	ø28	ø28	ø28	ø28	ø28	ø28	ø28
			Outlet	Φ, mm	ø28	ø28	ø28	ø28	ø28	ø28	ø28	ø28	ø28	ø28	ø28	ø28	ø28
		Leaving Water Temperature	Heating	°C	15~65	15~65	15~65	15~65	15~65	15~65	15~65	15~65	15~65	15~65	15~65	15~65	15~65
Cooling	°C		5~25	5~25	5~25	5~25	5~25	5~25	5~25	5~25	5~25	5~25	5~25	5~25	5~25		
Refrigerant Connections	Liquid Pipe		Φ, mm	6.35	6.35	6.35	6.35	6.35	6.35	6.35	6.35	6.35	6.35	6.35	6.35		
	Gas Pipe		Φ, mm	15.88	15.88	15.88	15.88	15.88	15.88	15.88	15.88	15.88	15.88	15.88	15.88		
	Installation Limitation	Max. Length	m	30	30	35	35	30	30	30	30	30	30	30	30		
		Max. Height	m	20	20	20	20	20	20	20	20	20	20	20	20		
	Chargeless Length		m	15	15	15	15	15	15	15	15	15	15	15	15	15	
Operating Temp. Range	Heating		°C	-25~35	-25~35	-25~35	-25~35	-25~35	-25~35	-25~35	-25~35	-25~35	-25~35	-25~35	-25~35		
	Cooling		°C	10~46	10~46	10~46	10~46	10~46	10~46	10~46	10~46	10~46	10~46	10~46	10~46		
	D.Hot Water		°C	-25~43	-25~43	-25~43	-25~43	-25~43	-25~43	-25~43	-25~43	-25~43	-25~43	-25~43	-25~43		

**Product Specifications (cont.)**

Model Name		Indoor Unit		AE200RNWSEG	AE200RNWSEG	AE200RNWSEG	AE260RNWSEG	AE260RNWSEG	AE260RNWSEG	AE260RNWSEG	
		Outdoor Unit		AE040RXEDEG	AE060RXEDEG	AE090RXEDEG	AE090RXEDEG	AE040RXEDEG	AE060RXEDEG	AE090RXEDEG	
Hydro Unit	Power Supply		Φ, #, V, Hz	1Φ, 2Line, 220~240V, 50Hz	1Φ, 2Line, 220~240V, 50Hz	1Φ, 2Line, 220~240V, 50Hz	3Φ, 4Line, 380~415V, 50Hz 1Φ, 2Line, 220~240V, 50Hz	1Φ, 2Line, 220~240V, 50Hz	1Φ, 2Line, 220~240V, 50Hz	1Φ, 2Line, 220~240V, 50Hz	
	Water Pump	Type (Model Name)	-	Centrifurugal (UPMM 25-9.5)	Centrifurugal (UPMM 25-9.5)	Centrifurugal (UPMM 25-9.5)	Centrifurugal (UPMM 25-9.5)	Centrifurugal (UPMM 25-9.5)	Centrifurugal (UPMM 25-9.5)	Centrifurugal (UPMM 25-9.5)	Centrifurugal (UPMM 25-9.5)
		Motor Input (Max)	W	100	100	100	100	100	100	100	100
		Number of Unit	EA	1	1	1	1	1	1	1	1
	Flow SENSOR	Type (Model Name)	-	FLOW SENSOR	FLOW SENSOR	FLOW SENSOR	FLOW SENSOR	FLOW SENSOR	FLOW SENSOR	FLOW SENSOR	FLOW SENSOR
		Min. flow rates	LPM	7.0	7.0	7.0	7.0	7.0	7.0	7.0	7.0
	Electric Heater		W	2,000	2,000	2,000	6,000	2,000	2,000	2,000	2,000
	Expansion Vessel		Liter	8	8	8	8	8	8	8	8
	Pressure Relief Valve		bar	2.9	2.9	2.9	2.9	2.9	2.9	2.9	2.9
	Air Purge Valve		Φ, inch	BSPP male 3/8"	BSPP male 3/8"	BSPP male 3/8"	BSPP male 3/8"	BSPP male 3/8"	BSPP male 3/8"	BSPP male 3/8"	BSPP male 3/8"
	Sound *3	Sound Pressure	Heating Std	dB(A)	26	26	26	26	26	26	26
			Cooling Std	dB(A)	26	26	26	26	26	26	26
		Sound Power	Heating Std	dB(A)	40	40	40	40	40	40	40
	External Dimension	Net Weight		kg	136	136	136	146	146	146	146
		Shipping Weight		kg	148	148	148	158	158	158	158
Net Dimensions (WxHxD)		mm	595x1800x700	595x1800x700	595x1800x700	595x1800x700	595x1800x700	595x1800x700	595x1800x700		
Shipping Dimensions (WxHxD)		mm	700 x 2,000 x 780	700 x 2,000 x 780	700 x 2,000 x 780	700 x 2,000 x 780	700 x 2,000 x 780	700 x 2,000 x 780	700 x 2,000 x 780		
Outdoor Unit	Power Supply		Φ, #, V, Hz	1Φ, 2Line, 220~240V, 50Hz	1Φ, 2Line, 220~240V, 50Hz	1Φ, 2Line, 220~240V, 50Hz	3Φ, 4Line, 380~415V, 50Hz	1Φ, 2Line, 220~240V, 50Hz	1Φ, 2Line, 220~240V, 50Hz	1Φ, 2Line, 220~240V, 50Hz	
	Compressor	Type	-	BLDC Twin Rotary	BLDC Twin Rotary	BLDC Twin Rotary	BLDC Twin Rotary	BLDC Twin Rotary	BLDC Twin Rotary	BLDC Twin Rotary	
		Model	-	UB4TN8200FE4SS	UB4TN8200FE4SS	UB8TN8265FJWSG	UB8TN8265FJWSG	UB4TN8200FE4SS	UB4TN8200FE4SS	UB8TN8265FJWSG	
		Oil Type	-	POE	POE	POE	POE	POE	POE	POE	
	Condenser	Size		-	2RX28S	2RX28S	2RX46S	2RX46S	2RX28S	2RX28S	2RX46S
		Type (Model)	-	SIC-67FV-F135-2	SIC-67FV-F135-2	FMD531SSA	FMD531SSA	SIC-67FV-F135-2	SIC-67FV-F135-2	FMD531SSA	
	Motor	Quantity	EA	1	1	1	1	1	1	1	
		CODE No	-	DB31-00492A	DB31-00492A	DB31-00579A	DB31-00579A	DB31-00492A	DB31-00492A	DB31-00579A	
		Air Flow Rate	Cooling	CMM	40	43	66	66	40	43	66
	Fan	Number of Unit		EA	1	1	1	1	1	1	1
		Type (Model)		-	SHF-7H-34U	SHF-7H-34U	SHF-11H	SHF-11H	SHF-7H-34U	SHF-7H-34U	SHF-11H
	4-Way Valve	Type (Model)		-	SHF-7H-34U	SHF-7H-34U	SHF-11H	SHF-11H	SHF-7H-34U	SHF-7H-34U	SHF-11H
	Base Heater	Power Input		W	N/A	N/A	150	150	N/A	N/A	150
	Sound*3	Sound Pressure	Heating Std	dB(A)	44	47	49	49	44	47	49
			Cooling Std	dB(A)	46	47	49	49	46	47	49
Night Mode			dB(A)	-	35	35	35	-	35	35	
Sound Power		Heating Std	dB(A)	58	60	64	64	58	60	64	
		Cooling Std	dB(A)	61	62	63	63	61	62	63	
External Dimension	Net Weight		kg	46.5	46.5	73.0	72.0	46.5	46.5	73.0	
	Shipping Weight		kg	49.5	49.5	81.5	80.5	49.5	49.5	81.5	
	Net Dimensions (WxHxD)		mm	880 x 638 x 310	880 x 638 x 310	940 x 998 x 330	940 x 998 x 330	880 x 638 x 310	880 x 638 x 310	940 x 998 x 330	
	Shipping Dimensions (WxHxD)		mm	1,023 x 742 x 413	1,023 x 742 x 413	995 x 1,178 x 426	995 x 1,178 x 426	1,023 x 742 x 413	1,023 x 742 x 413	995 x 1,178 x 426	
Refrigerant	Type		-	R32	R32	R32	R32	R32	R32	R32	
	Control Method		-	EEV	EEV	EEV	EEV	EEV	EEV	EEV	
	Factory Charging		g	1,200	1,200	1,400	1,400	1,200	1,200	1,400	







\*1) A2W Condition #1 : (Heating) Water In/Out 30°C/35°C, Outdoor Air 7°CDB/6°CWB; (Cooling) Water In/Out 23°C/18°C, Outdoor Air 35°C[DB].

\*2) A2W Condition for ESEER(Cooling) at Water Out 18°C.

\*3) Sound pressure was acquired in an anechoic room. Thus actual noise level may be different depending on the installation conditions.  
Night mode : Water In/Out 30°C/35°C, Outdoor Air : 7°C[DB]/6°C[WB], Measure point from unit : 3m.

**Product Specifications (cont.)**

**2-2-2 Outdoor Unit (Mono)**

Model Name		Indoor Unit		AE200RNWMEG	AE200RNWMEG	AE200RNWMEG	AE200RNWMEG	AE260RNWMGG	AE260RNWMGG	AE260RNWMGG							
		Outdoor Unit		AE050RXYDEG	AE080RXYDEG	AE120RXYDEG	AE160RXYDEG	AE080RXYDGG	AE120RXYDGG	AE160RXYDGG							
Outdoor Unit & Tank Hydro Unit Figure																	
System	Mode			Heat Pump (A2W)		Heat Pump (A2W)		Heat Pump (A2W)		Heat Pump (A2W)		Heat Pump (A2W)		Heat Pump (A2W)			
	A2W Condition #1. (H A7/W35 C A35/W18)*1	Nominal Capacity	Heating	W	5,000	8,000	12,000	16,000	8,000	12,000	16,000						
				Btu/h	17,100	27,300	40,900	54,600	27,300	40,900	54,600						
		Cooling	W	5,000	7,500	12,000	16,000	8,000	12,000	16,000							
			Btu/h	17,100	25,600	40,900	47,800	25,600	40,900	47,800							
		Power Input (Nominal)	Heating	W	1,030	1,770	2,650	3,620	1,770	2,650	3,620						
			Cooling	W	1,140	1,900	2,770	3,280	1,900	2,770	3,280						
		Current Input (Nominal)	Heating	A	4.9	8.5	12.2	17.0	2.8	4.1	5.7						
			Cooling	A	5.4	9.1	13.2	15.7	3.0	4.4	5.3						
		COP (Nominal Heating)		W/W	4.85	4.52	4.53	4.42	4.52	4.53	4.42						
		EER (Nominal Cooling)		W/W	4.39	3.95	4.33	4.27	3.95	4.33	4.27						
	PdesignH (LWT 35°C)		W	5,500	8,000	13,000	16,000	8,000	13,000	16,000							
	SCOP (35°C)		-	4.46	4.44	4.69	4.48	4.44	4.69	4.48							
	SEER *2		-	3.98	4.52	5.22	5.31	4.52	5.22	5.31							
	A7/W45	Capacity	Heating	W	4,800	7,400	11,700	15,400	7,400	11,700	15,400						
		COP		W/W	3.69	3.49	3.68	3.43	3.49	3.68	3.43						
	A7/W55	Capacity	Heating	W	4,300	7,100	11,300	15,000	7,100	11,300	15,000						
		COP		W/W	2.83	2.81	3.03	2.90	2.81	3.03	2.90						
	Performance (A2/W35)	Capacity	Heating	W	4,800	7,000	10,800	13,200	7,000	10,800	13,200						
		COP		W/W	3.31	2.98	3.27	3.00	2.98	3.27	3.00						
	Performance (A-7/W35)	Capacity	Heating	W	5,100	7,350	12,000	14,600	7,350	12,000	14,600						
		COP		W/W	2.71	2.43	2.55	2.43	2.43	2.55	2.43						
	Field Wiring	Tank Integrated Hydro Unit	MCA	A	22.70	22.70	22.70	22.70	3Φ 8.7 / 1Φ 14.0	3Φ 8.7 / 1Φ 14.0	3Φ 8.7 / 1Φ 14.0						
			Max Current	A	22.70	22.70	22.70	22.70	3Φ 8.7 / 1Φ 14.0	3Φ 8.7 / 1Φ 14.0	3Φ 8.7 / 1Φ 14.0						
			MFA	A	28.38	28.38	28.38	28.38	3Φ 10.9 / 1Φ 17.5	3Φ 10.9 / 1Φ 17.5	3Φ 10.9 / 1Φ 17.5						
		Outdoor Unit	MCA	A	16.0	22	28	32	10	10	12						
			Max Current	A	16.0	22	28	32	16.1	16.1	16.1						
			MFA	A	20.0	27.5	35	40	16.1	16.1	16.1						
Water Connections	Water Flow Rate (Heating/Cooling)		LPM	14.4/14.4	23.1/21.6	34.6/34.6	46.2/40.4	23.1/21.6	34.6/34.6	46.2/40.4							
	Water Pressure (Max)		bar	3	3	3	3	3	3	3							
	Water Pipe	Inlet	Φ, mm	ø28	ø28	ø28	ø28	ø28	ø28	ø28							
		Outlet	Φ, mm	ø28	ø28	ø28	ø28	ø28	ø28	ø28							
	Leaving Water Temperature	Heating	°C	15~65	15~65	15~65	15~65	15~65	15~65	15~65							
Cooling		°C	5~25	5~25	5~25	5~25	5~25	5~25	5~25								
Refrigerant	Type		-	R32	R32	R32	R32	R32	R32								
	Control Method		-	EEV INCLUDED	EEV INCLUDED	EEV INCLUDED	EEV INCLUDED	EEV INCLUDED	EEV INCLUDED	EEV INCLUDED							
	Factory Charging		g	1,000	1,150	2,200	2,200	1,150	2,200	2,200							
Hydro Unit	Power Supply		Φ, #, V, Hz	1Φ, 2Line, 220~240V, 50Hz	1Φ, 2Line, 220~240V, 50Hz	1Φ, 2Line, 220~240V, 50Hz	1Φ, 2Line, 220~240V, 50Hz	3Φ, 4Line, 380~415V, 50Hz 1Φ, 2Line, 220~240V, 50Hz	3Φ, 4Line, 380~415V, 50Hz 1Φ, 2Line, 220~240V, 50Hz	3Φ, 4Line, 380~415V, 50Hz 1Φ, 2Line, 220~240V, 50Hz							
	Water Pump	Type (Model Name)		-	Centrifurugal (UPMM 25-9.5)	Centrifurugal (UPMM 25-9.5)	"Centrifurugal (UPMM 25-9.5)"	Centrifurugal (UPMM 25-9.5)	Centrifurugal (UPMM 25-9.5)	Centrifurugal (UPMM 25-9.5)	Centrifurugal (UPMM 25-9.5)						
		Motor Input (Max)		W	100	100	100	100	100	100	100						
		Number of Unit		EA	1	1	1	1	1	1	1						

**Product Specifications (cont.)**

Model Name			Indoor Unit		AE200RNWMEG	AE200RNWMEG	AE200RNWMEG	AE200RNWMEG	AE260RNWMGG	AE260RNWMGG	AE260RNWMGG
			Outdoor Unit		AE050RXYDEG	AE080RXYDEG	AE120RXYDEG	AE160RXYDEG	AE080RXYDGG	AE120RXYDGG	AE160RXYDGG
Hydro Unit	Flow SENSOR	Type (Model Name)		-	FLOW SENSOR	FLOW SENSOR	FLOW SENSOR	FLOW SENSOR	FLOW SENSOR	FLOW SENSOR	FLOW SENSOR
		Min. flow rates		LPM	7.0	7.0	12.0	12.0	7.0	12.0	12.0
	Electric Heater		W	2,000	2,000	2,000	2,000	6,000	6,000	6,000	
	Expansion Vessel		Liter	8	8	8	8	8	8	8	
	Pressure Relief Valve		bar	2.9	2.9	2.9	2.9	2.9	2.9	2.9	
	Air Purge Valve		Φ, inch	BSP male 3/8"	BSP male 3/8"	BSP male 3/8"	BSP male 3/8"	BSP male 3/8"	BSP male 3/8"	BSP male 3/8"	
	Sound *3	Sound Pressure	Heating Std	dB(A)	26	26	30	30	26	30	30
			Cooling Std	dB(A)	26	26	30	30	26	30	30
		Sound Power	Heating Std	dB(A)	40	40	44	44	40	44	44
	External Dimension	Net Weight		kg	130	130	130	130	140	140	140
		Shipping Weight		kg	142	142	142	142	152	152	152
		Net Dimensions (WxHxD)		mm	595x1800x700	595x1800x700	595x1800x700	595x1800x700	595x1800x700	595x1800x700	595x1800x700
Shipping Dimensions (WxHxD)		mm	700 x 2,000 x 780	700 x 2,000 x 780	700 x 2,000 x 780	700 x 2,000 x 780	700 x 2,000 x 780	700 x 2,000 x 780	700 x 2,000 x 780		
Power Supply			Φ, #, V, Hz	1Φ, 2Line, 220~240V, 50Hz	1Φ, 2Line, 220~240V, 50Hz	1Φ, 2Line, 220~240V, 50Hz	1Φ, 2Line, 220~240V, 50Hz	3Φ, 4Line, 380~415V, 50Hz	3Φ, 4Line, 380~415V, 50Hz	3Φ, 4Line, 380~415V, 50Hz	
Compressor	Type		-	BLDC Twin Rotary	BLDC Twin Rotary	BLDC Twin Rotary	BLDC Twin Rotary	BLDC Twin Rotary	BLDC Twin Rotary	BLDC Twin Rotary	
	Model		-	UB4TN8200FE4SS	UB8TN8265FJWSG	UB5TN5450FJXSG	UB5TN5450FJXSG	UB8TN8265FJWSG	UB5TN5450FJXSG	UB5TN5450FJXSG	
Fan	Oil		-	POE	POE	POE	POE	POE	POE	POE	
	Air Flow Rate	Cooling	CMM	51	66	99	118	66	99	118	
Number of Unit		EA	1	1	2	2	1	2	2		
Base Heater		W	N/A	150	150	150	150	150	150	150	
Sound*3	Sound Pressure	Heating	dB(A)	45	48	50	52	48	50	52	
		Cooling	dB(A)	45	48	50	54	48	50	54	
	Sound Power	Heating	dB	61	63	64	66	63	64	66	
		Cooling	dB	62	64	65	68	64	65	68	
External Dimension	Net Weight		kg	58.5	76.0	110.0	110.0	75.0	111.0	111.0	
	Shipping Weight		kg	62.5	84.5	119.0	119.0	83.5	120.0	120.0	
	Net Dimensions (WxHxD)		mm	880 x 798 x 310	940 x 998 x 330	940 x 1,420 x 330	940 x 1,420 x 330	940 x 998 x 330	940 x 1,420 x 330	940 x 1,420 x 330	
	Shipping Dimensions (WxHxD)		mm	1,023x904x413	995 x 1,178 x 426	995 x 1,598 x 426	995 x 1,598 x 426	995 x 1,178 x 426	995 x 1,598 x 426	995 x 1,598 x 426	
Operating Temp. Range	Heating		℃	-25~35	-25~35	-25~35	-25~35	-25~35	-25~35	-25~35	
	Cooling		℃	10~46	10~46	10~46	10~46	10~46	10~46	10~46	
	DHW Tank		℃	-25~43	-25~43	-25~43	-25~43	-25~43	-25~43	-25~43	

\*1) A2W Condition #1 : (Heating) Water In/Out 30°C/35°C, Outdoor Air 7°CDB/6°CWB; (Cooling) Water In/Out 23°C/18°C, Outdoor Air 35°CDB.















\*2) A2W Condition for ESEER(Cooling) at Water Out 18°C.













\*3) Sound pressure was acquired in an anechoic room. Thus actual noise level may be different depending on the installation conditions.



## 2-3 Specifications of optional items









### 2-3-1 Accessories

Item	Description	Code No.	Q'ty	Remark
	Cap Drain	DB63-10355C	3 (5)	AE080/090/120/160RX** Model (AE040/060RX** Model)
	Drain Plug	DB67-00806A	1	AE080/090/120/160RX** Model
	Drain Plug	DB67-20011A	1	AE040/050/060RX** Model
	Rubber Leg	DB73-20134A	4	AE080/090/120/160RX** Model
	Rubber Leg	DB67-01533A	4	AE040/050/060RX** Model
	Installation Manual	DB68-08375A	1	AE040/060RX** Model
	Installation Manual	DB68-08368A	1	AE050RX** Model
	Installation Manual	DB68-08407A	1	AE090RX** Model
	Installation Manual	DB68-08408A	1	AE080/120/160RX** Model
	Instruction Manual	DB68-08423D	1	AE040/060RX** Model
	Instruction Manual	DB68-08423E	1	AE050RX** Model
	Instruction Manual	DB68-08409A	1	AE090RX** Model
	Instruction Manual	DB68-08410A	1	AE080/120/160RX** Model
	Installation Manual	DB68-08367A	1	AE200/260RNW***Model
	Instruction Manual	DB68-08422C	1	AE200/260RNW***Model

Item	Description	Code No.	Q'ty	Remark
	Zone sensor	DB95-04396A	2	AE200/260RNW***Model
	Sen Temp-Mixing Valve	DB32-00213A	1	
	Sensor holder	DB61-40055A	3	
	Sensor clip	DB81-00635A	3	
	Cable-tie	DB65-10088C	6	
	Aluminum Tape	DB72-30040A	3	
	Rubber Tape	DB62-11304A	3	
	Insulator	DB62-04785A	3	
	Tube Secondary	DB96-24724A	1	AE260RNW***Model
	Gasket	DB63-04197A	1	AE260RNW***Model
	Drain Plug Out	DB67-20011A	1	AE200/260RNW***Model
	Cap Drain	DB63-10355C	2	AE200/260RNW***Model

### 3. Disassembly and Reassembly

#### ■ Hand Tool sets



Item	Remark
+Screw Driver	
Adjustable wrench	
-Screw Driver	
Nipper	
Electric Motion Driver	
L-Wrench	
Torque Lench	
Latchet Lench	

### 3-1 Tank Integrated Hydro Unit

#### ■ AE200RNW\*\*G/AE260RNW\*\*G

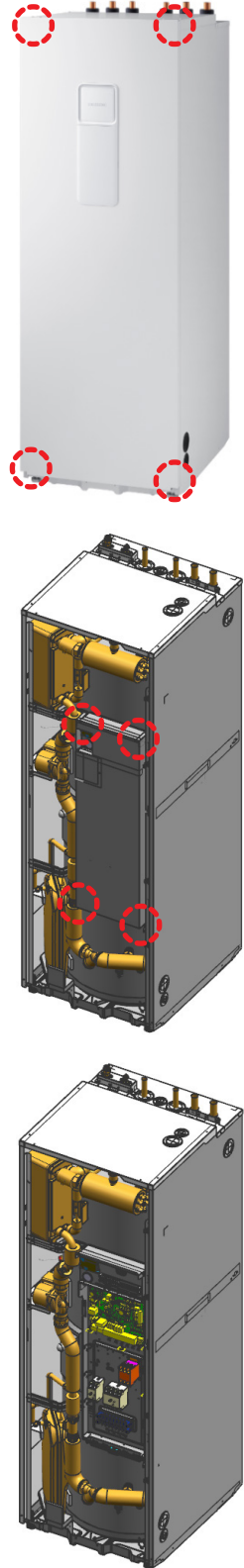
Be sure that the power switch is in the OFF and the power source cord shall be unplugged prior to disassembly and reassembly works.

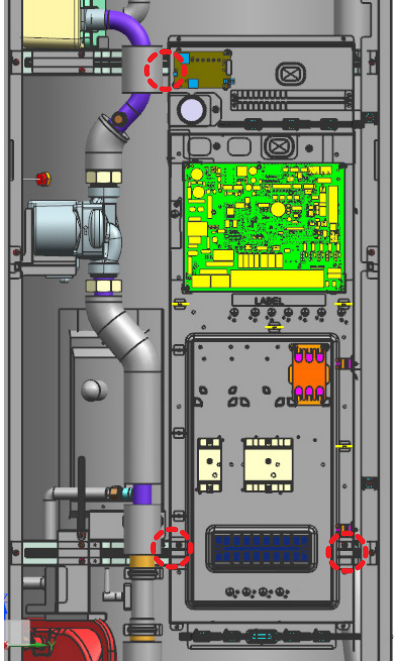
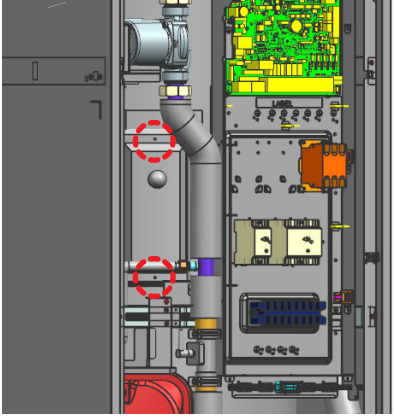
No	Parts	Procedure	Remark
1	ELECTRICAL EQUIPMENT PARTS	<p>1) Remove ** screws from the Cabinet. (Use + Screw Driver)</p> <p>2) Remove the 4 screws and then separate the Cover Control Box part. (Use + Screw Driver)</p> <p>3) Remove the Power, Pump, 3way valve, Flow sensor, Booster Heater, Back-up Heater, Sensor connector of Assy PCB.</p>	

No	Parts	Procedure	Remark
		<p>4) Remove the 3 screws from the front part.</p>	
		<p>5) Remove the 2 screw and then open the cover in the middle position of water tank.</p>	
		<p>6) Remove the wire of the thermostat and booster heater.</p>	

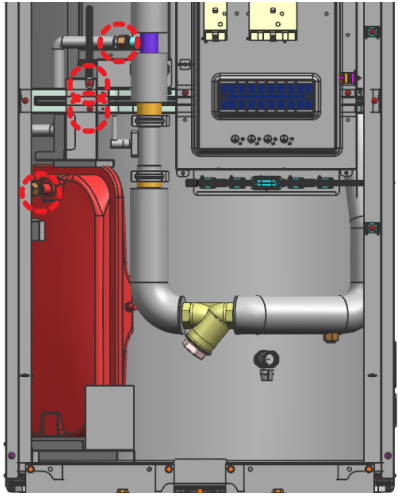
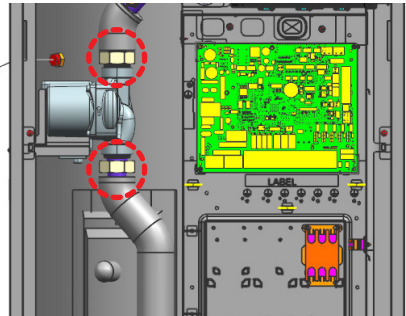
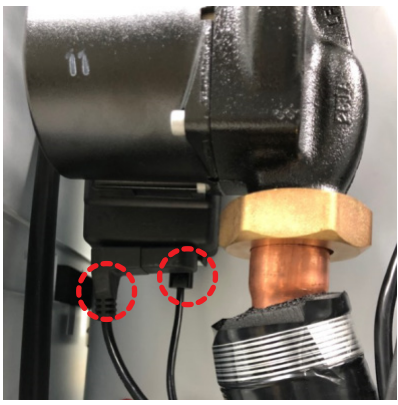
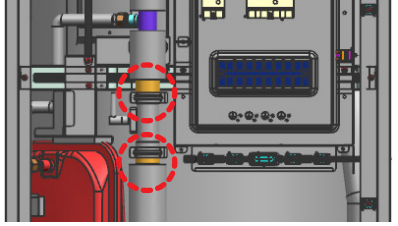
No	Parts	Procedure	Remark
2	EXPANSION VESSEL	1) Remove the 2 screw from the front parts.  2) Separate the pipe connected expansion vessel by 2 nut joints.	
3	PUMP	1) Disconnect power and communication connection.  2) Separate the pipe connected Pump by 2 nut joints.	 
4	Flow sensor	1) Separate the pipe connected flow sensor by 2 bracket holder.	

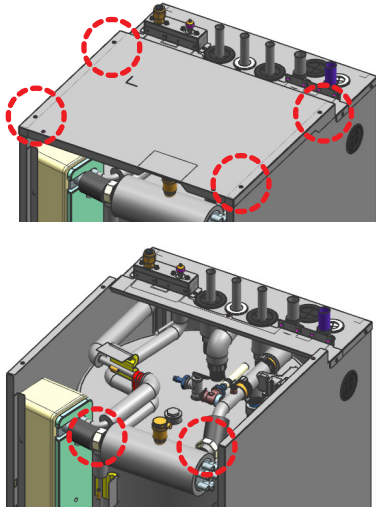
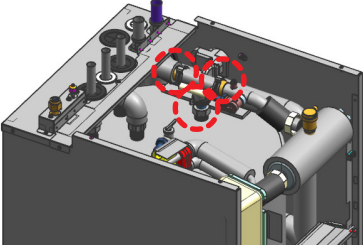
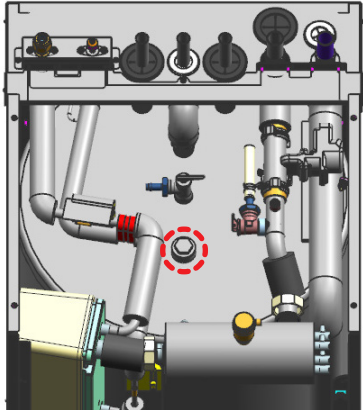

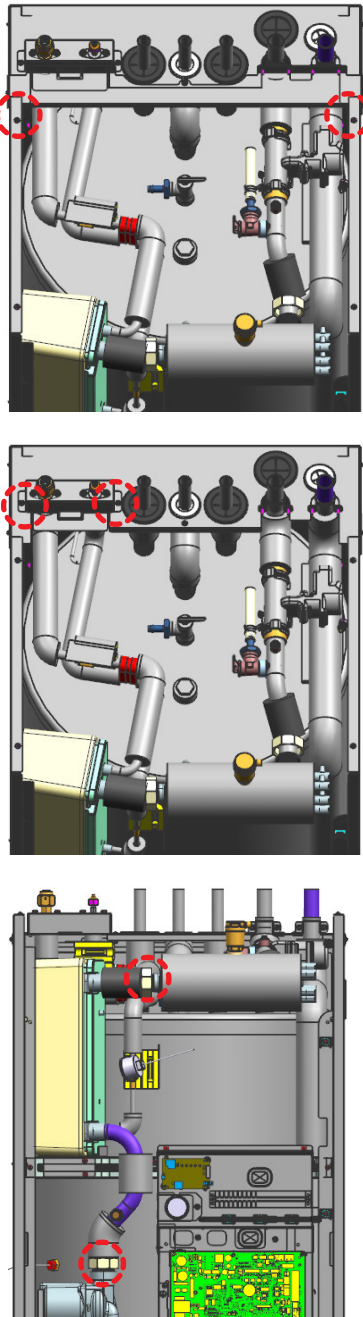
No	Parts	Procedure	Remark
5	Back up Heater	1) Remove the 4 screw front the cabi top parts.  2) Separate the pipe connected Back up heater by 2 nut joints.	
6	3way Valve	1) Separate the pipe connected 3way valve by 3 bracket holder.	
7	Anode bar	1) Separate the pipe connected anode bar by 1 nut joint from top of the tank.	



No	Parts	Procedure	Remark
8	PLATE HEAT EXCHANGER	<p>1) Remove the 2 screw from the bracket valve.</p> <p>2) Remove the 2 screw front the cabi top sub.</p> <p>3) Separate the pipe connected Assy plate heat exchanger by 2 nut joint.</p>	





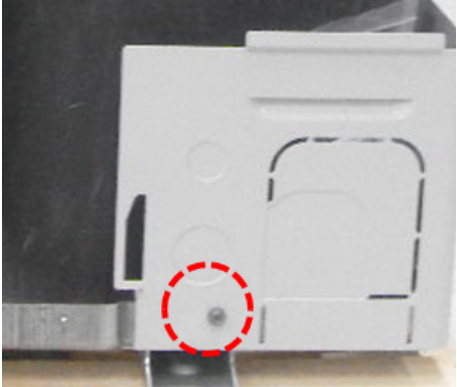

## 3-2 Outdoor Unit

### ■ AE090RXED\*

No	Parts	Procedure	Remark
1	CABI FRONT RH	<p><b>⚠ You must turn off the power before disassembling.</b></p> <p>1) Unscrew and remove the three screws on the CABI FRONT RH. (Use '+' type screw driver)</p>	
2	CABI TOP	<p>1) Unscrew and remove the nine screws on each side of the CABI TOP. (Use '+' type screw driver)</p>	
3	CABI INSTALL FRONT	<p>1) Unscrew and remove the screw on the CABI INSTALL FRONT. (Use '+' type screw driver)</p>	

No	Parts	Procedure	Remark
4	GUARD COND	<p>1) Pull the sensor from Guard Cond.</p> <p>2) Unscrew and remove the four screws on the GUARD COND. (Use '+' type screw driver)</p>	 

No	Parts	Procedure	Remark
5	CABI BACK RH	<p>1) Pull the sensor from the CABI BACK RH.</p> <p>2) Unscrew and remove the nine screws on each side the CABI BACK RH. (Use '+' type screw driver)</p>	  

No	Parts	Procedure	Remark
			
6	CABI INSTALL BACK	1) Unscrew and remove the 8 screws on the CABI FRONT LF. (Use '+' type screw driver)	

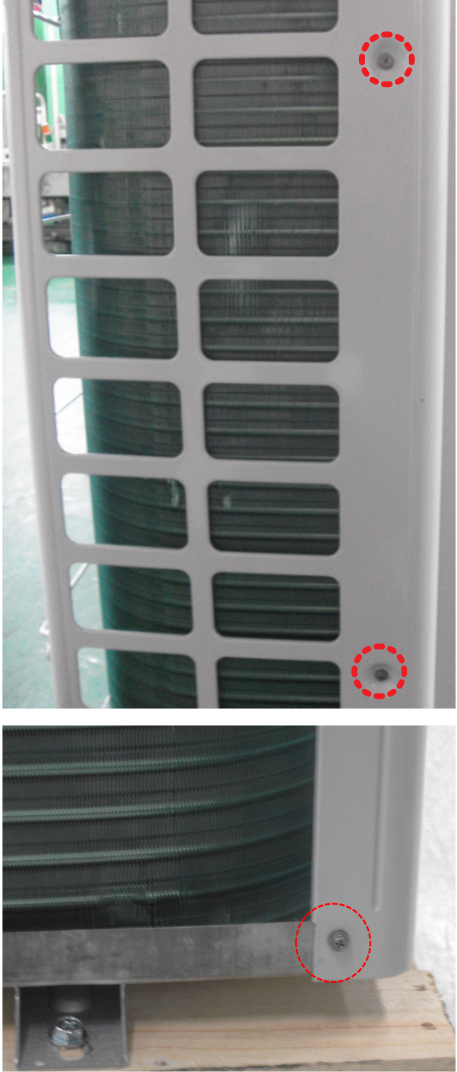
No	Parts	Procedure	Remark
			

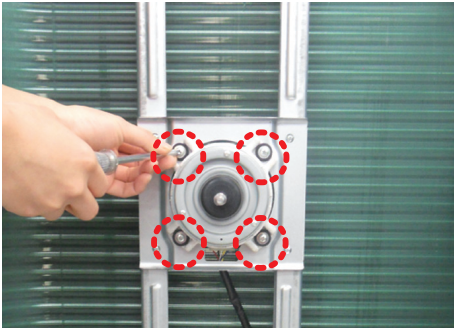
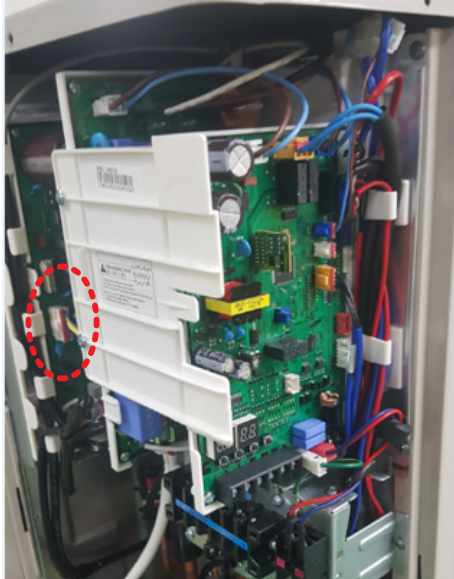
No	Parts	Procedure	Remark
7	FAN	1) Turn the one nut as shown in the picture and remove it. (Use adjustable wrench)	
8	MOTOR	1) Remove the fan. 2) Unscrew and remove the four motor screws. (Use '+' type screw driver)  3) Disconnect the motor wire from the Ass'y Control Out.	 



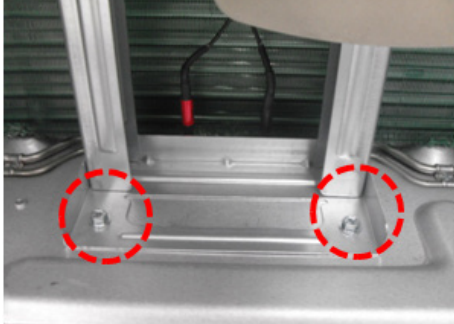

No	Parts	Procedure	Remark
9	BRACKET MOTOR	1) Unscrew and remove the two screws on the BRACKET MOTOR. (Use '+' type screw driver)	

No	Parts	Procedure	Remark
10	CONTROL OUT	<p>1) Disconnect the six connectors from the ASSY Control OUT</p> <p>2) Unscrew and remove the three screws on the CONTROL OUT. (Use '+' type screw driver)</p> <p>3) Separate the ASSY CONTROL OUT.</p>	

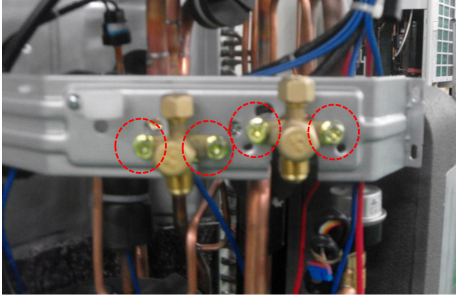
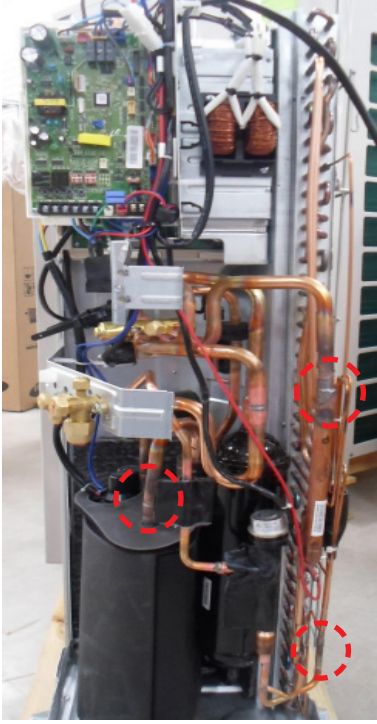
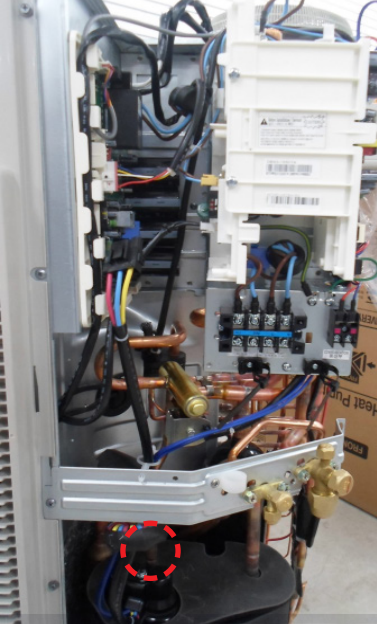



No	Parts	Procedure	Remark
11	ASSY 4WAY VALVE	<ol style="list-style-type: none"> <li>1) Purge the coolant first.</li> <li>2) Unscrew and remove the four screws on the SERVICE VALVE. (Use '+' type screw driver)</li>   <li>3) Separate the pipe from the Entrance/Exit using a welder.</li> </ol> <p style="color: red;">⚠ When removing the compressor, heat exchanger and pipe, purge the completely and remove the pipe with a welding flame.</p>	  

No	Parts	Procedure	Remark
12	COMPRESSOR	<p>1) Unscrew and remove the nut on the COVER TERMINAL. (Use adjustable wrench)</p> <p>2) Separate the compressor wire.</p> <p>3) separate the OUTSIDE COMPRESSOR FELT SOUND</p>	

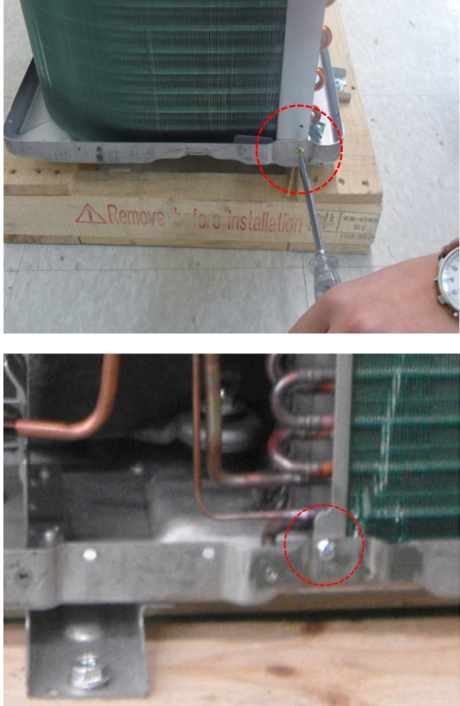
No	Parts	Procedure	Remark
		<p>4) Separate the COMPRESSOR FELT SOUND.</p> <p>5) As shown in the picture, unscrew and bottom. (Use Adjustable Wrench)</p>	

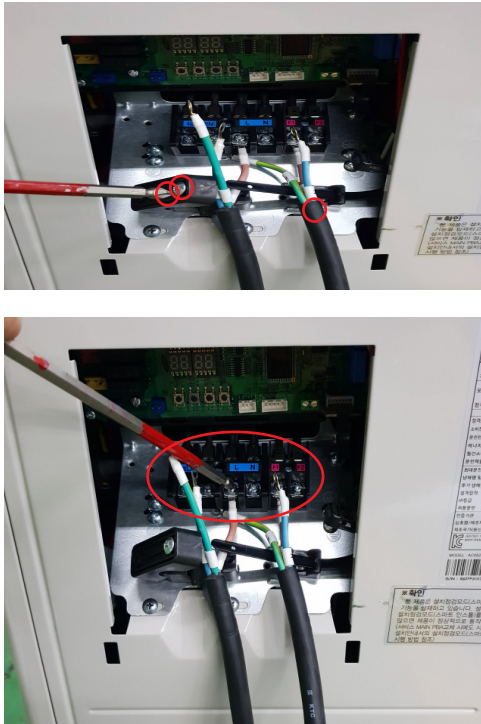

No	Parts	Procedure	Remark
13	ASSY COND OUT	1) Unscrew remove the two screws on each side of the ASSY COND OUT. (Use '+' type screw driver)	

■ AE040RXED\*/AE060RXED\*

No	Parts	Procedure	Remark
1	CABI TOP	1) Unscrew and remove 8 screws on each side of the Cabinet-Top. (Use + Screw Driver)	
2	ASS'Y COVER CONTROL	1) Unscrew and remove a screw of Cover-Control. (Use + Screw Driver)	
3	OUTDOOR AND INDOOR UNIT'S POWER CABLE AND COMMUNICATION CABLE	<p>⚠ Make sure shutting the power off supply before disassembling</p> <p>1) Unscrew 2 fix screws under cable holders and remove.</p> <p>2) Get rid of cable tie of communication cable.</p> <p>3) Unscrew the numbers of screws on terminal block and separate power and communication 'Ring'cables from terminal block.</p>	



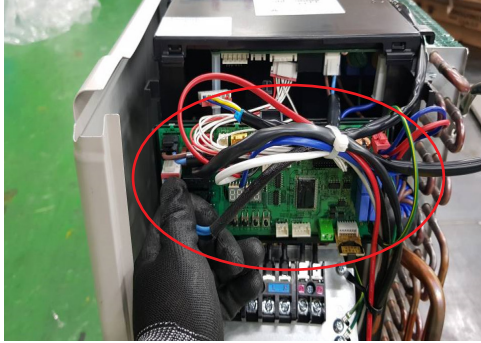
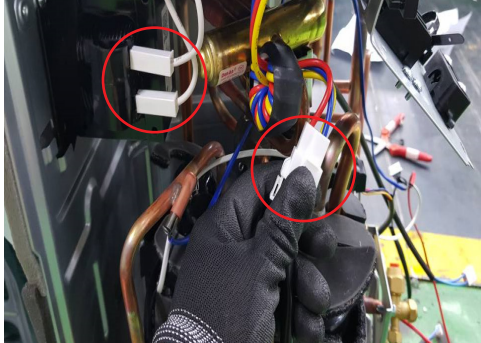
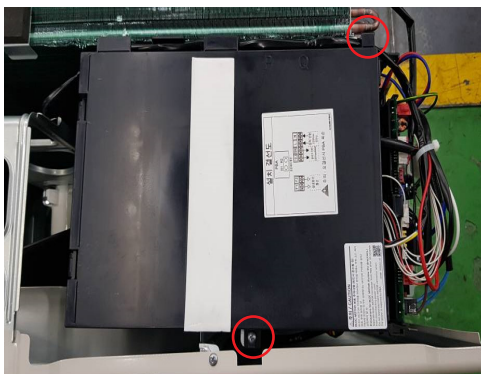

No	Parts	Procedure	Remark
4	ASS'Y CABINET SIDE RH	1) Unscrew and remove 9 screws on Cabinet-side rh. (Use + Screw Driver)	 <p>The first photograph shows the right side of the cabinet with a terminal block. Nine screws are circled in red: two on the top edge, two on the bottom edge, and five on the side panel. The second photograph shows the side panel being removed, with the same nine screws circled in red to indicate their removal points.</p>
5	ASS'Y CABINET FRONT	1) Unscrew and remove 8 screws on Assy Cabinet Front. (Use + Screw Driver)	 <p>The first photograph shows the front of the cabinet with a large circular fan grille. Eight screws are circled in red: two on the top edge, two on the bottom edge, and four on the side panel. The second photograph shows the front panel removed, with the same eight screws circled in red to indicate their removal points.</p>

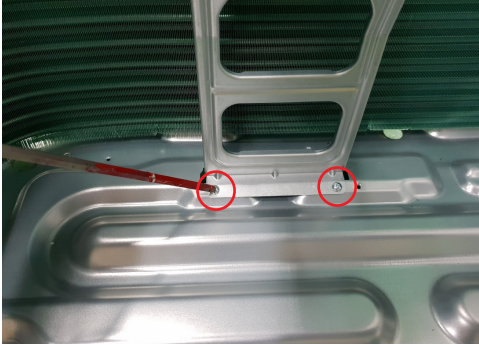
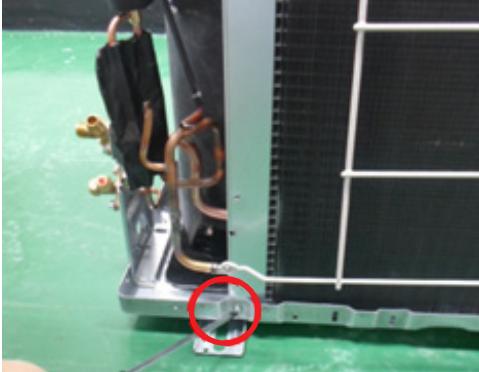

No	Parts	Procedure	Remark
6	ASS'Y CONTROL OUT	<p>1) Disconnect and Separate 5 Connectors of wire from Assy Control Out.</p> <p>2) Separate Comp wire and Reactor wire from each object.</p> <p><b>⚠ (When you disconnect BLDC motor connector you have to cut the power off first and disconnect 30 seconds later And Make sure that is impossible to connect and disconnect BLDC motor connector when the power is on)</b></p> <p>3) Unscrew and remove 2 screws on of Assy Control out.</p>	  
7	FAN PROPELLER + MOTOR	<p>1) Take Fan Propeller apart.</p> <p>2) Unscrew and remove 4 screws on Motor to take apart Motor. (Use + Screw Driver)</p>	 

No	Parts	Procedure	Remark
8	ASS'Y BRACKET MOTOR	1) Unscrew and remove 2 screws on to take apart Bracket Motor. (Use + Screw Driver)	
9	HEAT EXCHANGER	1) Purge the Refrigerant first.  2) Unscrew the fix screw.  3) Separate the pipe from the Entrance and Exist by using a welder.  4) Separate Heat Exchanger from Unit.  <b>⚠ When removing the Compressor, Heat Exchanger, and Pipe, Purge the Refrigerant inside the Compressor completely and remove the pipe with a weld-ing flame.</b>	



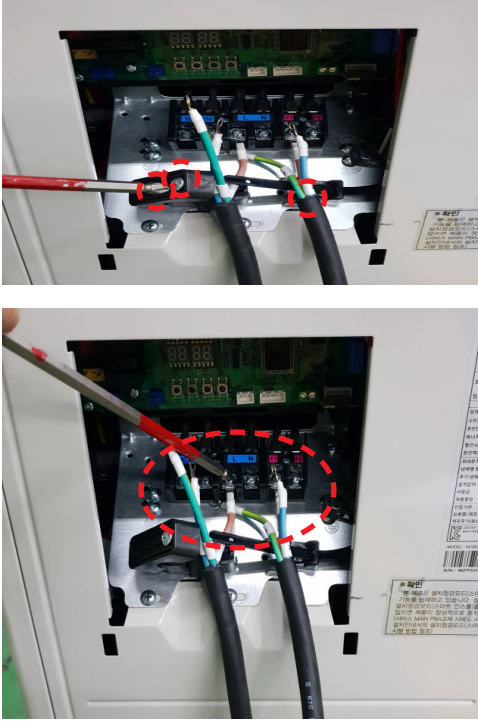

■ AE050RXYD\*\*

No	Parts	Procedure	Remark
1	CABI TOP	<p><b>⚠ You must turn o the power before disassembling.</b></p> <p>1) Unscrew and remove the ten screws on each side of the CABI TOP. (Use '+' type screw driver)</p>	
2	ASS'Y COVER CONTROL	<p>1) Unscrew and remove the one screw on the ASSY COVER CONTROL. (Use '+' type screw driver)</p>	
3	OUTDOOR AND INDOOR UNIT'S POWER CABLE AND COMMUNICATION CABLE	<p><b>⚠ Make sure shutting the power off supply before disassembling</b></p> <p>1) Unscrew 2 fix screws under cable holders and remove.</p> <p>2) Get rid of cable tie of communication cable.</p> <p>3) Unscrew the numbers of screws on terminal block and separate power and communication 'Ring'cables from terminal block.</p>	

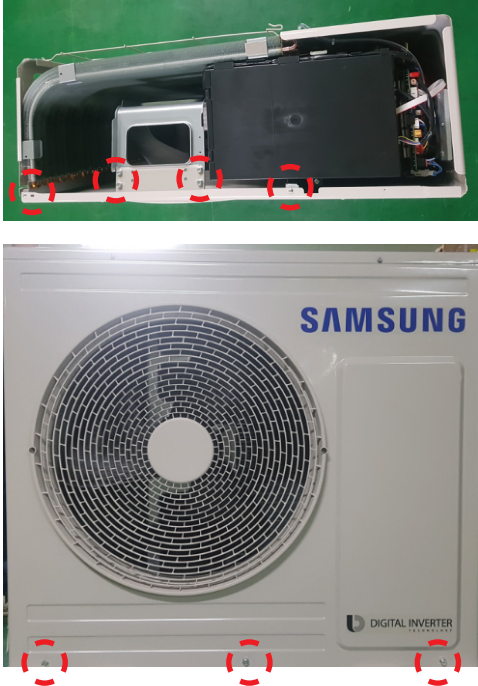
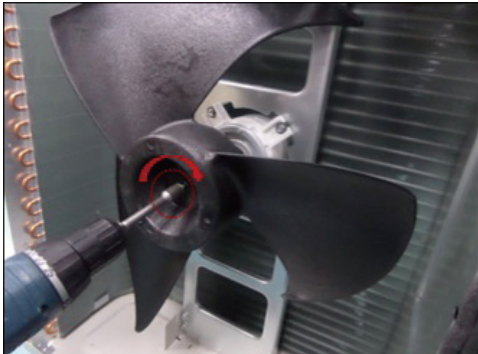
No	Parts	Procedure	Remark
4	GUARD COND	<p>1) Pull the sensor from Guard Cond.</p> <p>2) Unscrew and remove the four screws on the GUARD COND. (Use '+' type screw driver)</p>	
5	CABI SIDE RH	<p>1) Unscrew and remove the eleven screws on each side of the CABI BACK RH. (Use '+' type screw driver)</p> <p>2) Pull the sensor from the CABI SIDE RH.</p>	

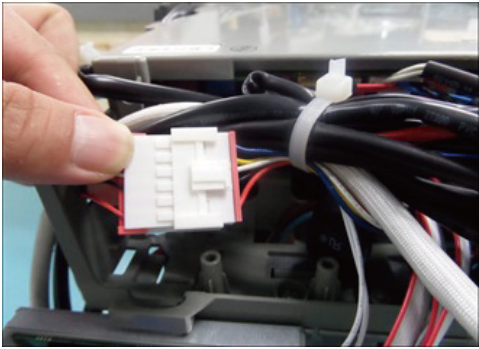
No	Parts	Procedure	Remark
6	CABI FRONT	1) Unscrew and remove the 9 screws on the CABI FRONT. (Use '+' type screw driver)	
7	FAN	1) Turn the one nut as shown in the picture and remove it. (Use adjustable wrench)	

No	Parts	Procedure	Remark
8	MOTOR	<p>1) Remove the fan.</p> <p>2) Unscrew and remove the four motor screws. (Use '+' type screw driver)</p> <p>3) Disconnect the motor wire from the Ass'y Control Out.</p>	 
9	BRACKET	<p>1) Unscrew and remove the two screws on the BRACKET MOTOR. (Use '+' type screw driver)</p>	

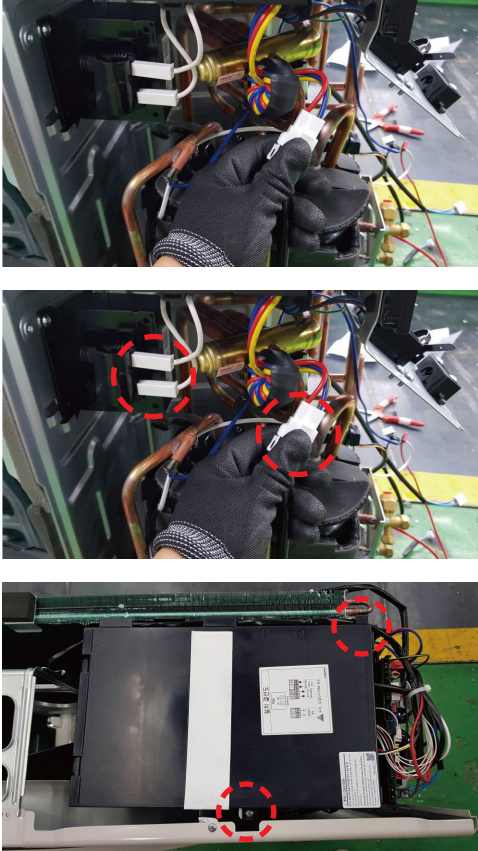
No	Parts	Procedure	Remark
10	ASS'Y CONTROL OUT	<p>1) Disconnect and Separate 5 Connectors of wire from Assy Control Out.</p> <p>2) Separate Comp wire and Reactor wire from each object.</p> <p><b>⚠ (When you disconnect BLDC motor connector you have to cut the power off first and disconnect 30 seconds later And Make sure that is impossible to connect and disconnect BLDC motor connector when the power is on)</b></p> <p>3) Unscrew and remove 2 screws on of Assy Control out.</p>	



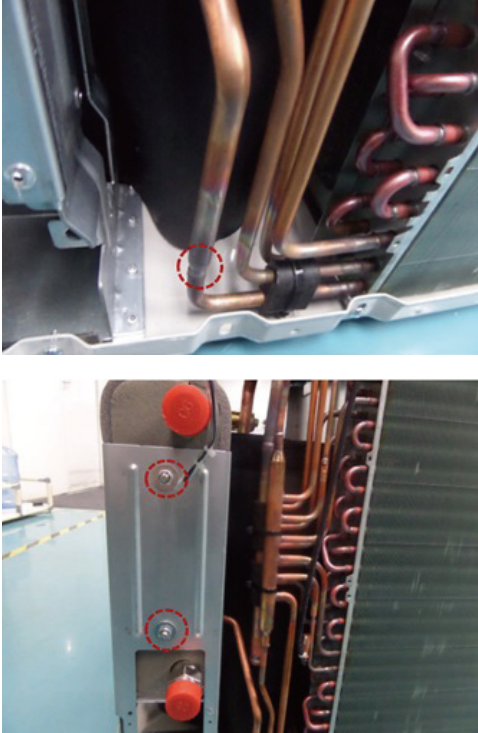

No	Parts	Procedure	Remark
11	ASSY-VALVE 4WAY	1) Purge the coolant first.  2) Separate the pipe from the Entrance/Exit using a welder.  ⚠ When removing the compressor, heat exchanger and pipe, purge the completely and remove the pipe with a welding ame.	
12	ASSY TUBE-WATER	1) Purge the coolant first.  2) Turn the two nuts as shown in the picture and remove them. (Use adjustable wrench)	

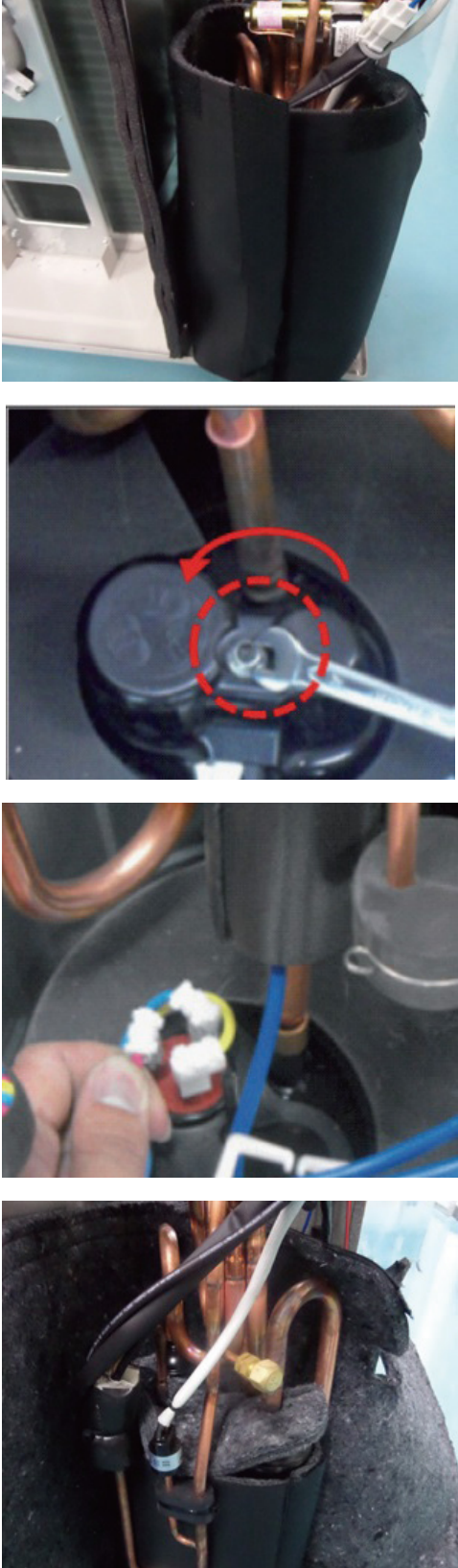

No	Parts	Procedure	Remark
13	ASSY BRACKET PHE	1) Unscrew and remove the 4 screws on the ASSY BRACKET PHE. (Use '+' type screw driver)	

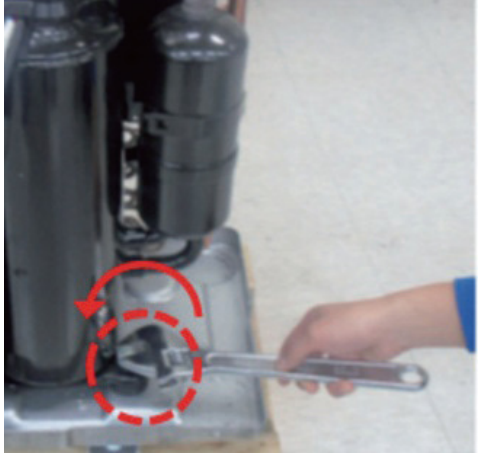

No	Parts	Procedure	Remark
14	COMPRESSOR	<p>1) Separate the COMPRESSOR FELT SOUND.</p> <p>2) Unscrew and remove the nut on the COVER TERMINAL. (Use adjustable wrench)</p> <p>3) Separate the compressor wire.</p> <p>4) Separate the COMPRESSOR FELT SOUND.</p>	

No	Parts	Procedure	Remark
		5) As shown in the picture, unscrew and bottom. (Use Adjustable Wrench)	
15	ASSY COND OUT	1) Unscrew and remove the four screws as shown in the picture. (Use '+' type screw driver)	

## ■ AE120/160RXD\*\*

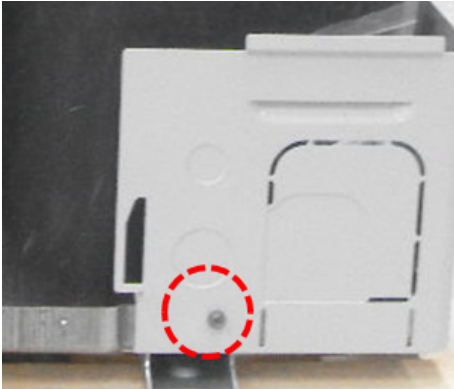
No	Parts	Procedure	Remark
1	CABI FRONT RH	<p><b>⚠ You must turn off the power before disassembling.</b></p> <p>1) Unscrew and remove the three screws on the CABI FRONT RH. (Use '+' type screw driver)</p>	
2	CABI TOP	<p>1) Unscrew and remove the nine screws on each side of the CABI TOP. (Use '+' type screw driver)</p>	
3	CABI INSTALL FRONT	<p>1) Unscrew and remove the screw on the CABI INSTALL FRONT. (Use '+' type screw driver)</p>	

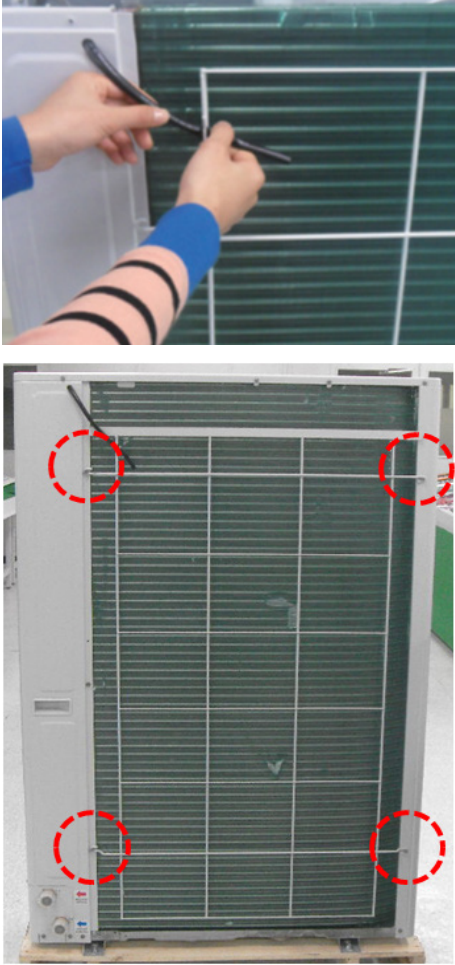
No	Parts	Procedure	Remark
4	GUARD COND	<p>1) Pull the sensor from Guard Cond.</p> <p>2) Unscrew and remove the four screws on the GUARD COND. (Use '+' type screw driver)</p>	

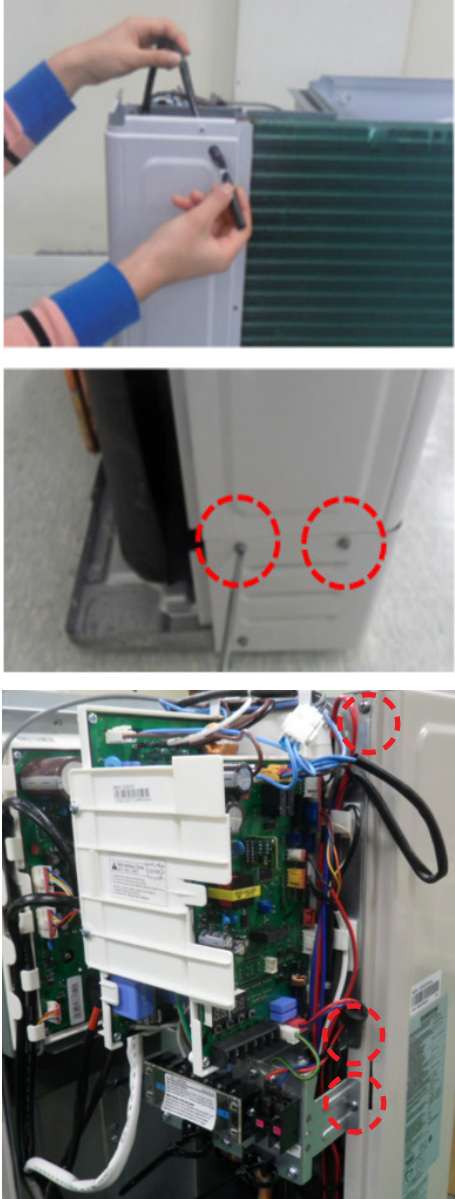
No	Parts	Procedure	Remark
5	CABI BACK RH	<p>1) Pull the sensor from the CABI BACK RH.</p> <p>2) Unscrew and remove the nine screws on each side the CABI BACK RH. (Use '+' type screw driver)</p>	

No	Parts	Procedure	Remark
			
6	CABI INSTALL BACK	<p>1) Unscrew and remove the 7 screws in the Cabinet-Install Back. (Use '+' type screw driver)</p>	



No	Parts	Procedure	Remark
7	CABI FRONT LF	1) Unscrew and remove 10 screws. in the Cabinet-Front LF. (Use '+' type screw driver)	

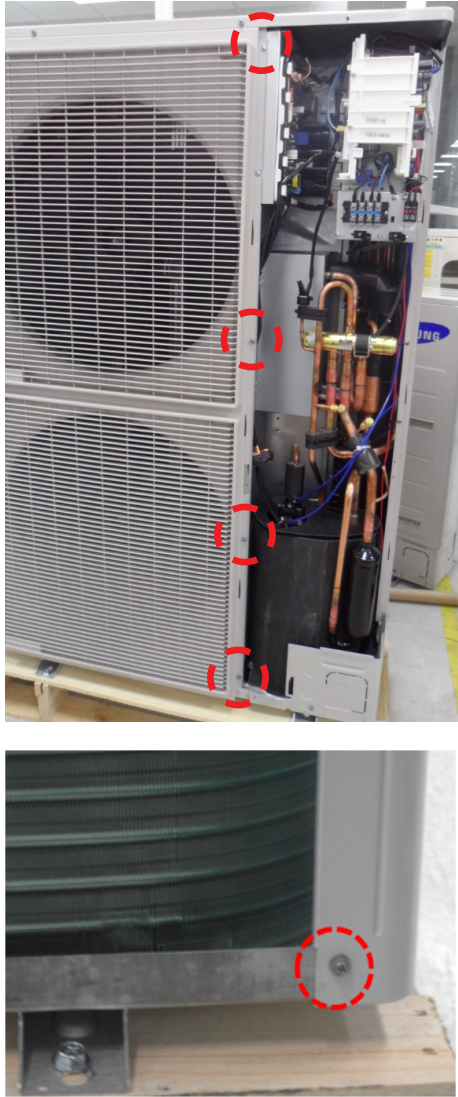

No	Parts	Procedure	Remark
			 <p>The top photograph shows the back of an outdoor air conditioning unit with its front grille removed. Red dashed circles highlight the screws along the top and side edges of the metal cabinet. The bottom photograph is a close-up of a corner screw being removed from the unit's frame.</p>

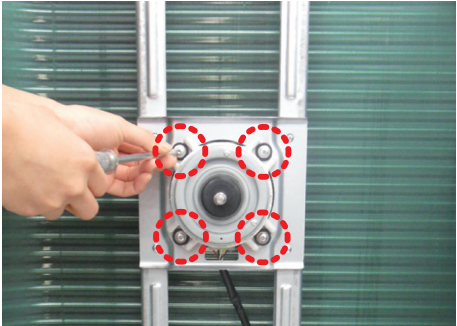
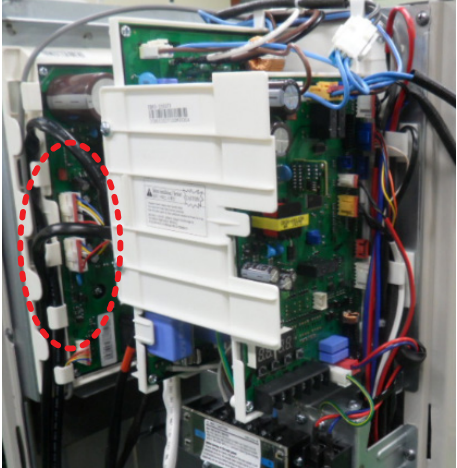
No	Parts	Procedure	Remark
8	FAN	1) Turn the two nuts as shown in the picture and remove them. (Use adjustable wrench)	
9	MOTOR	1) Remove the fan. 2) Unscrew and remove the eight motor screws. (Use '+' type screw driver)  3) Disconnect the motor wire from the Ass'y Control Out.	 

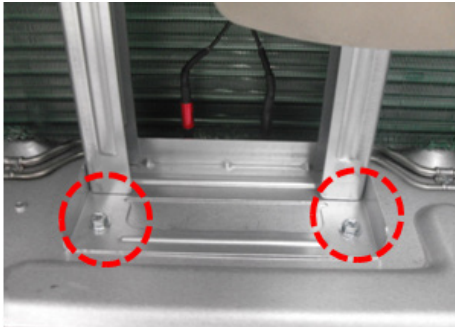
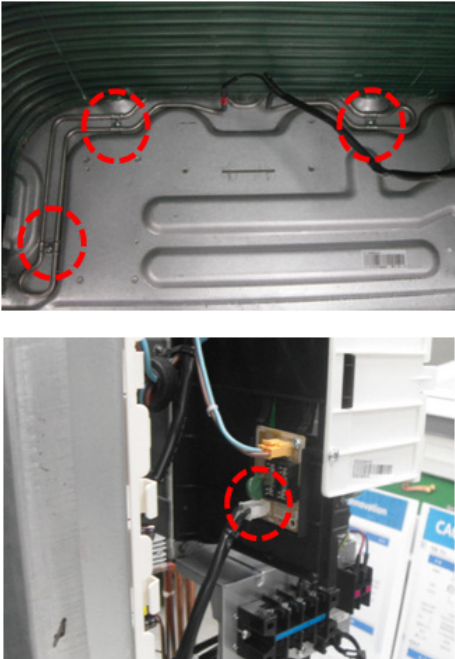
No	Parts	Procedure	Remark
10	BRACKET MOTOR	1) Unscrew and remove the two screws on the BRACKET MOTOR. (Use '+' type screw driver)	
11	HEATER	1) Unscrew and remove the three screws on the BRACKET MOTOR. (Use '+' type screw driver)  2) Disconnect the heater wire from the ASSY CONTROL OUT.	

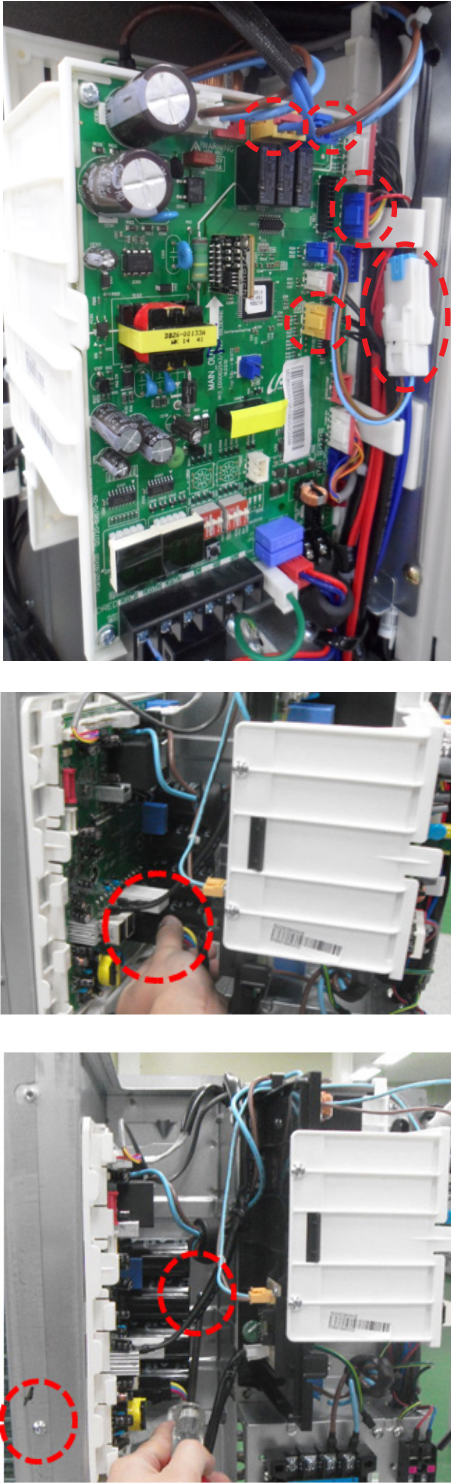
No	Parts	Procedure	Remark
12	CONTROL OUT	<p>1) Disconnect the six connectors from the ASSY CONTROL OUT</p> <p>2) Unscrew and remove the two mounting screws on the CONTROL OUT. (Use '+' type screw driver)</p> <p>3) Separate the ASSY CONTROL OUT.</p>	

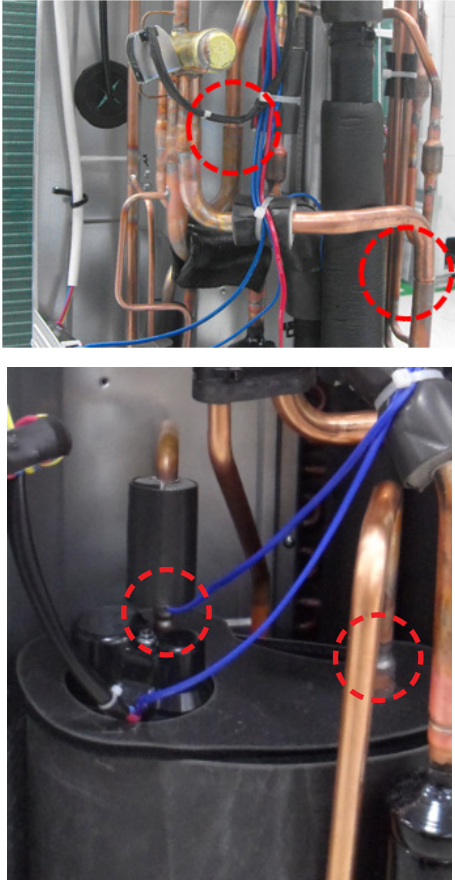
No	Parts	Procedure	Remark
13	ASSY 4WAY VALVE	<p>1) Purge the coolant first.</p> <p>2) Separate the pipe from the Entrance/Exit using a welder.</p> <p><b>⚠ When removing the compressor, heat exchanger and pipe, purge the completely and remove the pipe with a welding flame.</b></p>	

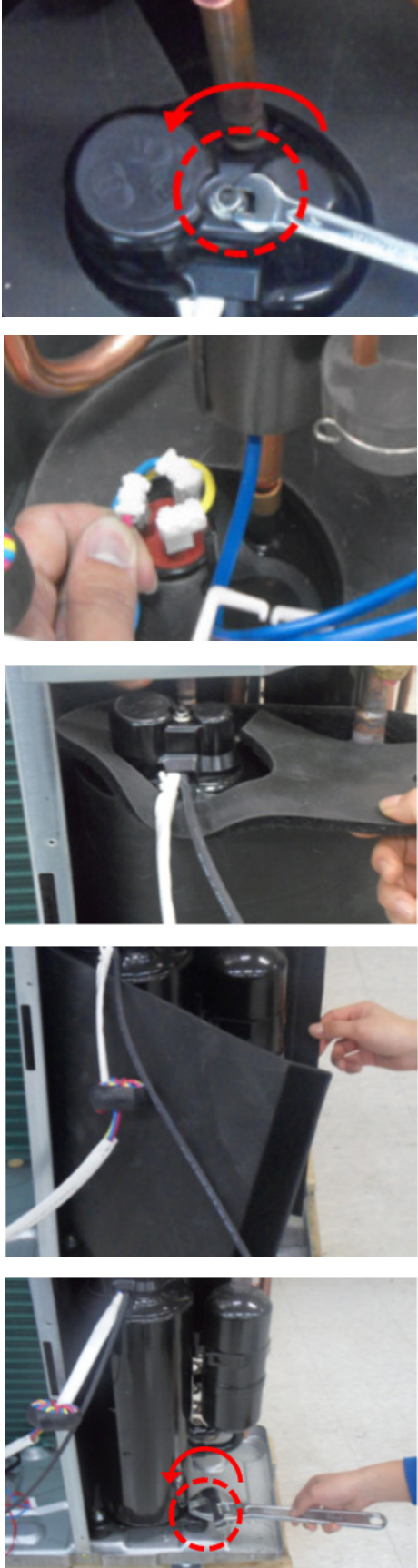

No	Parts	Procedure	Remark
14	COMPRESSOR	<p>1) Unscrew and remove the nut on the COVER TERMINAL. (Use adjustable wrench)</p> <p>2) Separate the compressor wire.</p> <p>3) Separate the COMPRESSOR FELT SOUND.</p> <p>4) As shown in the picture, unscrew and remove 3 mounting screws from the bottom. (Use Adjustable Wrench)</p>	

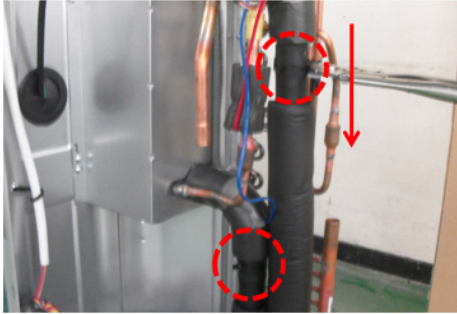

No	Parts	Procedure	Remark
15	ASS'Y WATER TUBE IN/OUT	1) Separate the Hose from the Water tube using a pleyer.	

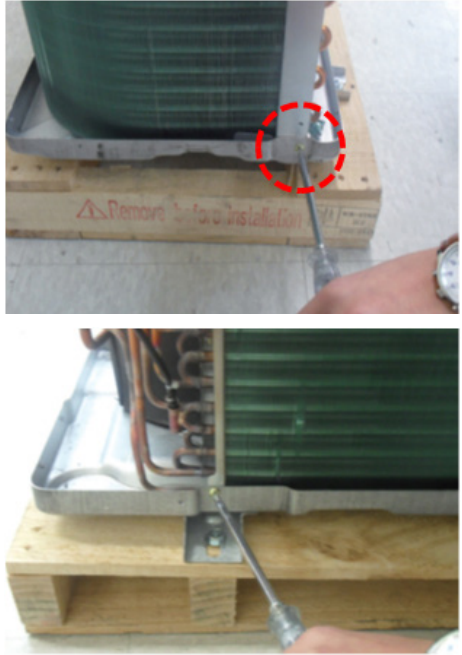

No	Parts	Procedure	Remark
16	ASSY PHE	<p>1) Unscrew and remove 2 screws in Partition. (Use '+' type screw driver)</p> <p>2) Separate the Bracket PHE Top.</p> <p>3) Separate the pipe from the Entrance/Exit using a welder.</p> <p>4) As shown in the picture, unscrew and remove 2 mounting screws from the partition. (Use Adjustable Wrench)</p>	

No	Parts	Procedure	Remark
17	ASSY COND OUT	1) Unscrew and remove 2 screws on each side of the Assy Cond Out. (Use '+' type screw driver)	

## ■ AE080XYD\*\*

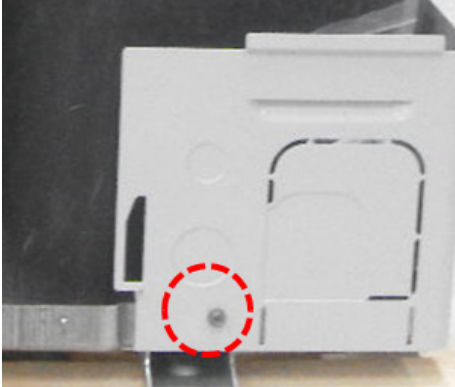
No	Parts	Procedure	Remark
1	CABI FRONT RH	<p><b>⚠ You must turn off the power before disassembling.</b></p> <p>1) Unscrew and remove the three screws on the CABI FRONT RH. (Use '+' type screw driver)</p>	
2	CABI TOP	<p>1) Unscrew and remove the nine screws on each side of the CABI TOP. (Use '+' type screw driver)</p>	
3	CABI INSTALL FRONT	<p>1) Unscrew and remove the screw on the CABI INSTALL FRONT. (Use '+' type screw driver)</p>	

No	Parts	Procedure	Remark
4	GUARD COND	<p>1) Pull the sensor from Guard Cond.</p> <p>2) Unscrew and remove the four screws on the GUARD COND. (Use '+' type screw driver)</p>	

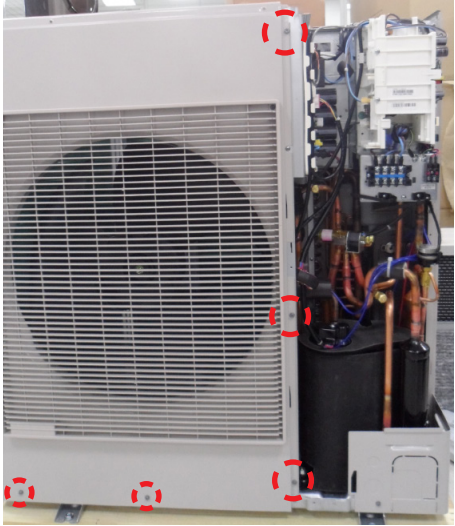

No	Parts	Procedure	Remark
5	CABI BACK RH	<p>1) Pull the sensor from the CABI BACK RH.</p> <p>2) Unscrew and remove the nine screws on each side the CABI BACK RH. (Use '+' type screw driver)</p>	

No	Parts	Procedure	Remark
			
6	CABI INSTALL BACK	<p>1) Unscrew and remove the 8 screws on the CABI FRONT LF. (Use '+' type screw driver)</p>	

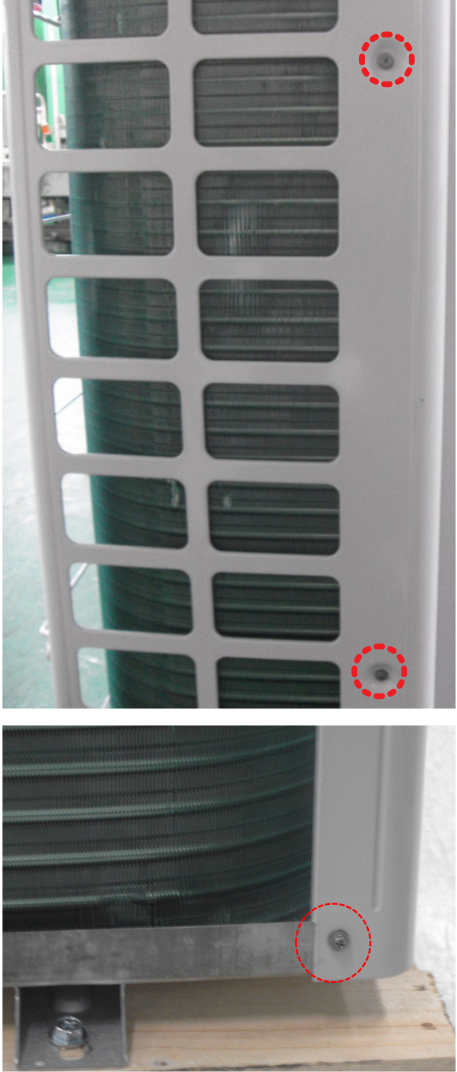

No	Parts	Procedure	Remark
			

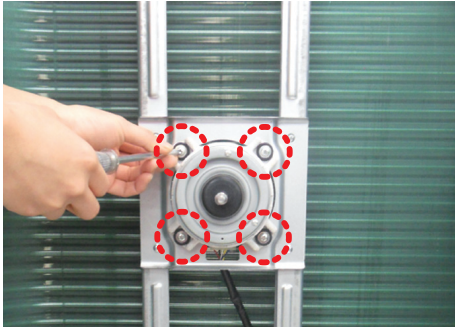

No	Parts	Procedure	Remark
7	FAN	1) Turn the one nut as shown in the picture and remove it. (Use adjustable wrench)	
8	MOTOR	1) Remove the fan. 2) Unscrew and remove the four motor screws. (Use '+' type screw driver)  3) Disconnect the motor wire from the Ass'y Control Out.	 

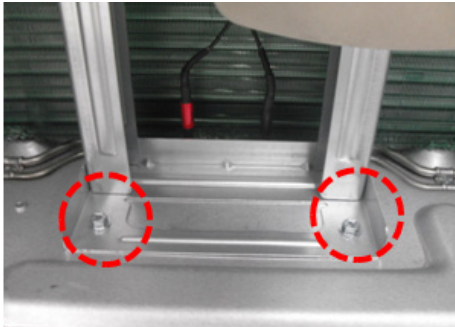
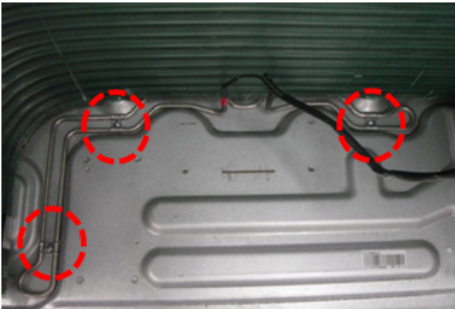
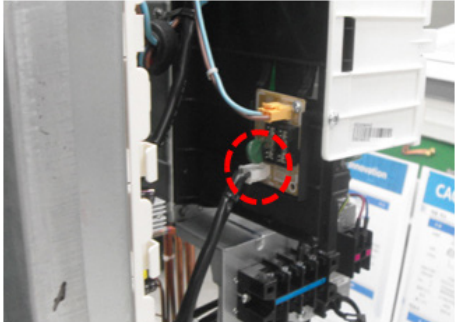
No	Parts	Procedure	Remark
9	BRACKET MOTOR	1) Unscrew and remove the two screws on the BRACKET MOTOR. (Use '+' type screw driver)	
10	HEATER	1) Unscrew and remove the three screws on the BRACKET MOTOR. (Use '+' type screw driver)  2) Disconnect the heater wire from the ASSY CONTROL OUT.	 

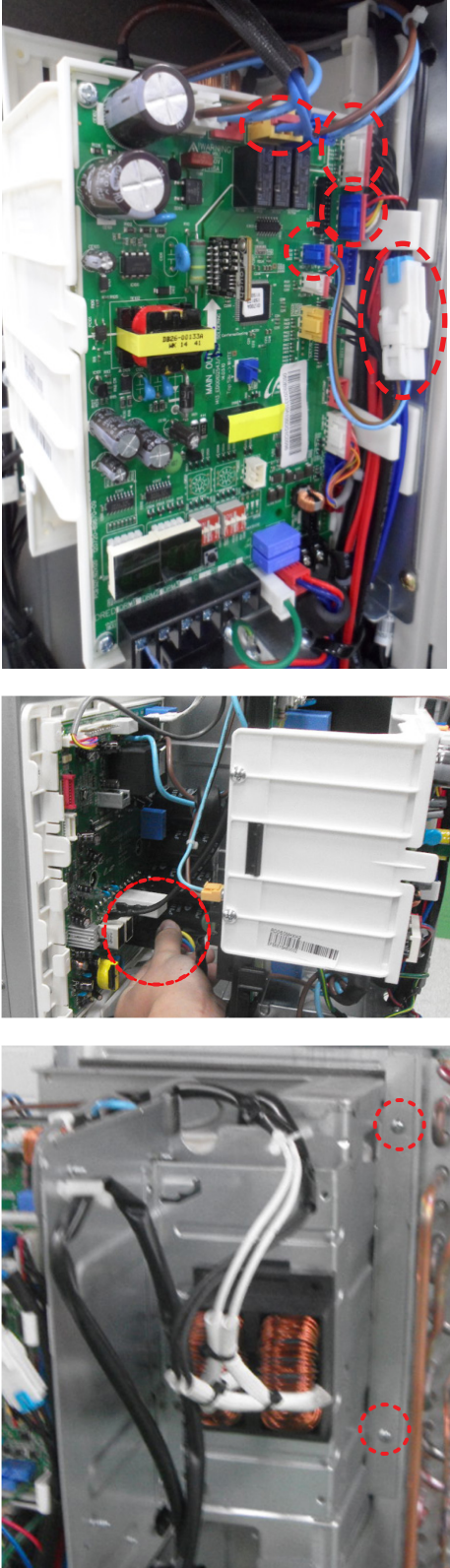
No	Parts	Procedure	Remark
11	CONTROL OUT	<p>1) Disconnect the six connectors from the ASSY CONTROL OUT</p> <p>2) Unscrew and remove the three screws on the CONTROL OUT. (Use '+' type screw driver)</p> <p>3) Separate the ASSY CONTROL OUT.</p>	

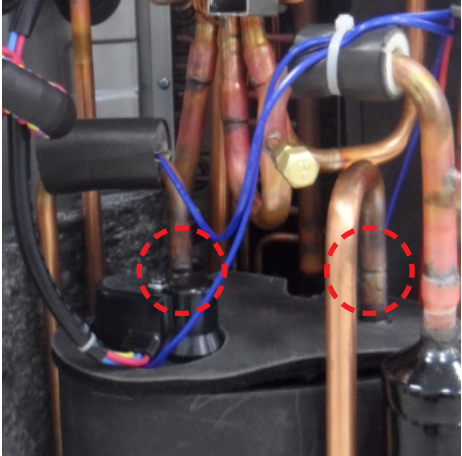
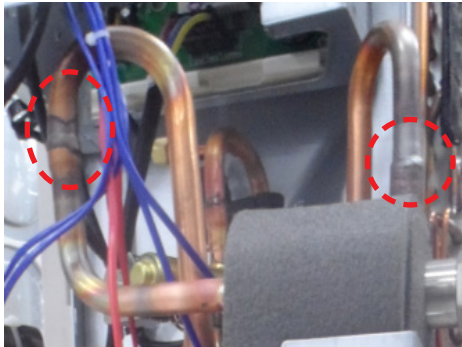
No	Parts	Procedure	Remark
12	ASSY 4WAY VALVE	<p>1) Purge the coolant first.</p> <p>2) Separate the pipe from the Entrance/Exit using a welder.</p> <p><b>⚠ When removing the compressor, heat exchanger and pipe, purge the completely and remove the pipe with a welding flame.</b></p>	 

No	Parts	Procedure	Remark
13	COMPRESSOR	<p>1) Unscrew and remove the nut on the COVER TERMINAL. (Use adjustable wrench)</p> <p>2) Separate the compressor wire.</p> <p>3) Separate the COMPRESSOR FELT SOUND.</p> <p>4) As shown in the picture, unscrew and bottom. (Use Adjustable Wrench)</p>	

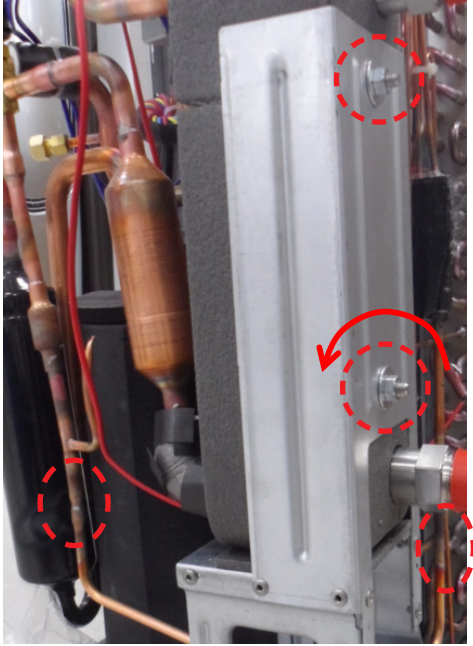
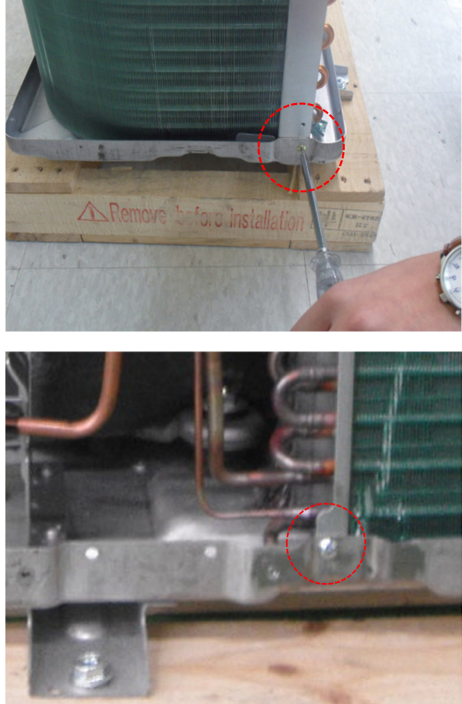

No	Parts	Procedure	Remark
14	ASSY PHE	1) Separate the pipe from the Entrance/Exit using a welder. 2) As shown in the picture, unscrew and remove the two screws from the BRACKET PHE. (Use adjustable wrench)	
15	ASSY COND OUT	1) Unscrew remove the two screws on each side of the ASSY COND OUT. (Use '+' type screw driver)	



## 4. Troubleshooting

### 4-1 Wired remote controller

- Press the Test button to see the error code.

Error mode	Contents	Measure	Product operation in error condition	Error type
			Outdoor unit/ Compressor/Indoor unit	
101	Indoor unit communication error	Check the communication cable of indoor unit. Check the DC output voltage at the communication terminal.	Operation Off	Communication error
108	Indoor unit address setting error	Check address setting of indoor units.	Operation Off	Communication error
109	Indoor unit communication error	Check indoor units quantity setting in outdoor unit. Check electrical connection and setting	Operation Off	Communication error
120	Indoor temperature sensor (open/short error) -Zone2	Check indoor unit room temperature sensor. Check indoor unit PCB connector CNS043 Terminal(B15/B16)	Operation Off	Indoor sensor error
121	Indoor temperature sensor (open/short error) -Zone1	Check indoor unit room temperature sensor. Check indoor unit PCB connector CNS043(White)	Operation Off	Indoor sensor error
122	Indoor unit Eva In sensor (Open/Short)	Check indoor unit Eva in sensor location.	Operation Off	Indoor sensor error
123	Indoor unit Eva Out sensor disconnection	Check indoor unit Eva out sensor location.	Operation Off	Indoor sensor error
162	EEPROM Error	Refer to details.		
201	Indoor/outdoor communication error (Matching error)	Refer to details.		
202	Indoor/outdoor communication error (3 min)	Refer to details.		
203	Communication error between indoor/outdoor INV ↔ MAIN MICOM (4~6 min)	Refer to details.		
221	Outdoor temperature sensor error	Refer to details.		
231	Condenser temperature sensor error	Refer to details.		
251	Discharge temperature sensor error	Refer to details.		
320	OLP sensor error	Refer to details.		
403	Detection of OUTDOOR UNIT compressor freezing	Check cycle status. (Outdoor unit (Condenser) froze. Check condenser)	Operation Off	Outdoor Unit error
404	Protection of OUTDOOR UNIT when it is overload	Check cycle status. (Please check same as E461 and check compressor when it starts)	-	Outdoor Unit error
407	Comp down due to high pressure	Check cycle status.	restart operation	Outdoor Unit error
416	Emission temperature excessively high	No error (DISCHARGE temperature control)	-	Outdoor unit protection control error
425	Miss wiring error at 3Phase power source line (Only 3Phase Model)	Check Power Line-R,S,T,N.	restart operation	Outdoor Unit error
440	Heating operation blocked	Check the operation setting state . Check temperature sensor.	Operation Off	Self diagnostic error
441	Cooling operation blocked	Check the operation setting state . Check temperature sensor.	Operation Off	Self diagnostic error

## Wired remote controller (cont.)

Error mode	Contents	Measure	Product operation in error condition	Error type
			Outdoor unit/ Compressor/Indoor unit	
458	Outdoor fan 1 error	Check input power connection status . Check the connection status between the motor and outdoor unit PCB Check indoor/outdoor fuse.	Operation Off	Self diagnostic error
461	[Inverter] Compressor startup error	Check the compressor connection status . Check the resistance between difference phases of the compressor.	Operation Off	Outdoor unit protection control error
462	[Inverter] Total current error/ PFC over current error	Check the input power. Check the coolant charging status . Check the normal operation of outdoor fan.	Operation Off	Outdoor unit protection control error
463	OLP over heat and comp stop	Check OLP sensor.	Operation Off	Self diagnostic error
464	[Inverter] IPM over current error	Check coolant charging. Check the compressor connection status and normal operation . Check the obstacles around the indoor and outdoor units. Check whether the outdoor unit service valve is open. Check whether the indoor/outdoor installation pipe/ wiring are correct.	Operation Off	Outdoor unit protection control error
465	Compressor V limit error	Check the compressor connection status . Check the resistance between difference phases of the compressor.	Operation Off	Outdoor unit protection control error
466	DC LINK over/low voltage error	Check input power . Check AC power connection.	Restart in 3 minutes	Outdoor unit protection control error
467	[Inverter] Compressor rotation error	Check the compressor connection status . Check the resistance between difference phases of the compressor.	Operation Off	Outdoor unit protection control error
468	[Inverter] Current sensor error	Check EEPROM DATA. Check the normal operation of PCB.	Operation Off	Outdoor unit protection control error
469	[Inverter] DC LINK voltage sensor error	Check the input power connection. Check the status of RY21 and R200 in the INVERTER PCB.	Operation Off	Outdoor unit protection control error
470	EEPROM read/write error	Check EEPROM of outdoor unit.	Operation Off	Outdoor Unit error
471	[Inverter] OTP error	Check EEPROM DATA. Check the normal operation of PCB.	Operation Off	Outdoor unit protection control error
474	IPM(IGBT Module) or PFCM temperature sensor Error	Exchange INVERTER PBA.	Operation Off	Outdoor Unit error
475	Outdoor fan 2 error	Check the input power connection status. Check the connection status of the motor and the outdoor unit PCB. Check the indoor/outdoor unit fuse.	Operation Off	Self diagnostic error
484	PFC Overload Error	Check reactor located in control plate. If reactor is normal, exchange INVERTER PBA.	Operation Off	Outdoor Unit error
485	Input current sensor error	Check Outdoor Inverter PBA.	Operation Off	Outdoor Unit error
500	IPM is overheated	Check INVERTER PBA's temperature. Power off and cool down INVERTER PBA, and then restart the outdoor unit.	Operation Off	Outdoor Unit error

## Wired remote controller (cont.)

Error mode	Contents	Measure	Product operation in error condition	Error type
			Outdoor unit/Compressor/Indoor unit	
554	Gas leak error	Check the coolant charging status Check the indoor EVA sensor. Check if the outdoor unit service valve is open. Check that the indoor/outdoor installation pipe/wiring are correct.	Operation Off	Self diagnostic error
590	Inverter EEPROM loading error	Check EEPROM DATA. Check the normal operation of PCB.	Operation Off	Comp down error
601	Communication error between the Hydro Unit and wired remote controller	Check the Indoor unit PBA and wired remote controller .	Operation Off	communication error
604	Wired remote communication error	Communication tracking error between the CONTROL KIT and wired remote controller.	Operation Off	Wired Remote Controller
653	Wired remote controller temp sensor SHORT or OPEN	Check sensor connection status.	Operation Off	wired remote controller sensor error
654	Memory(EEPROM) Read Write error(Wired remote controller data error)	Check the wired remote controller .	Operation Off	communication error
899	Zone 1 water-out temperature sensor error	Short- or open-circuit error of the Zone 1 water-out temperature sensor.	Operation Off	Indoor Unit error
900	Zone 2 water-out temperature sensor error	Short- or open-circuit error of the Zone 2 water-out temperature sensor.	Operation Off	Indoor Unit error
901	Water inlet (PHE) temperature sensor error	Refer to details.		
902	Water outlet (PHE) temperature sensor error	Refer to details.		
903	Water outlet (backup heater) temperature sensor error.	Refer to details.		
904	DHW tank temperature sensor error	Refer to details.		
906	Refrigerant gas inlet (PHE) temperature sensor	Refer to details.		
911	Low flow rate error	Refer to details.		
912	Normal flow rate error	Refer to details.		
914	Thermostat wrong connection error	Check the wiring of Hydro Unit Thermostat. Check the Cooling /Heating signal : Concurrent wiring or not.	Operation Off	Indoor sensor error
916	Mixing Valve Outlet temperature sensor error	Refer to details.		
919	Error for disinfection operation	Error that the set temperature for disinfection operation is not reached, or, after reaching, the temperature fails to continue for the requested time.	-	Indoor Unit error

## 4-2 Troubleshooting by symptoms

### 4-2-1 Communication error after finishing Tracking

Indoor unit display	E604
Symptom	Communication error between the indoor and outdoor unit for two minutes
Failure	Communication error between the indoor unit and outdoor unit

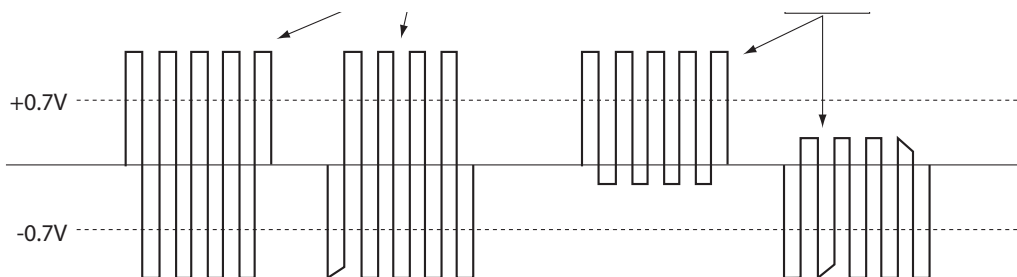
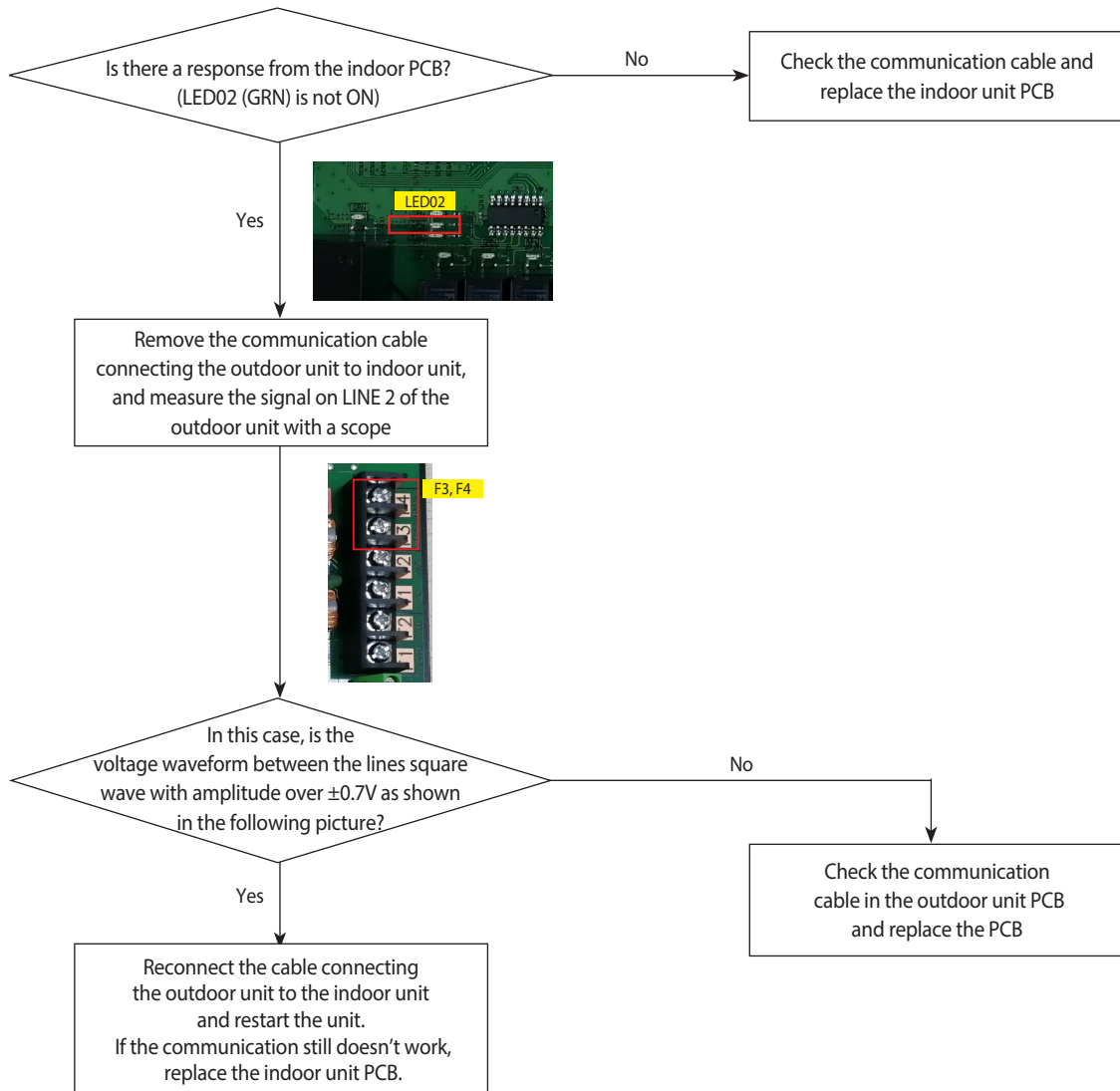

## 4-3 Hydro Unit

### 4-3-1 EEPROM error

Outdoor unit display	<i>E 162</i>
Indoor unit display	×(Operation) ●(Timer) ●(Fan) ●(Filter) ×(Defrost)
Criteria	• Communication failure between EEPROM and MICOM
Cause of problem	• PCB replacement due to defective EEPROM

#### 1. How to check

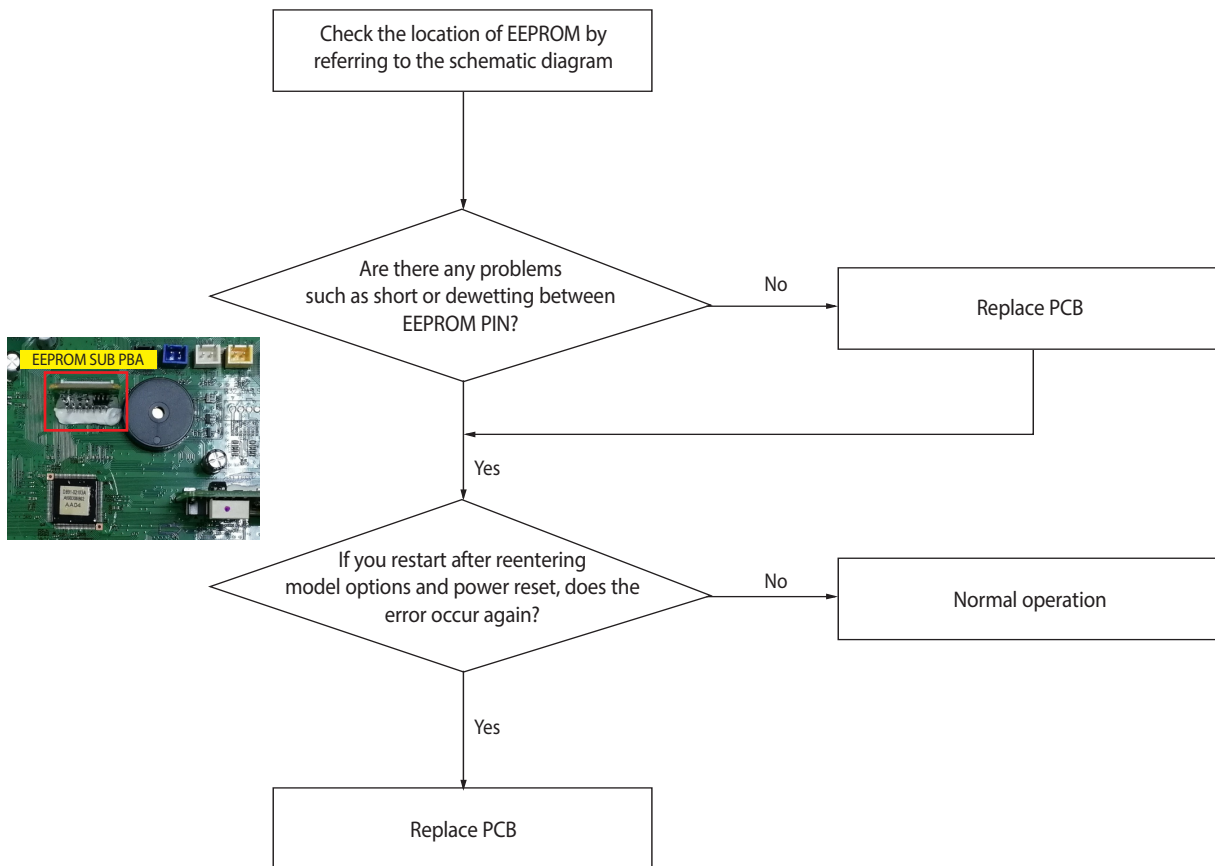

### 4-3-2 Water pump & Flow Sensor error

Wired remote display	E911
Criteria	• Refer to how to determine below
Cause of problem	Low flow rate error • In case of low flow rate in 30 sec during water pump signals is ON(Starting) • In case of low flow rate in 15 sec during water pump signals is ON(After Starting)

- How to check  
 \* Water pump is detected only during operation

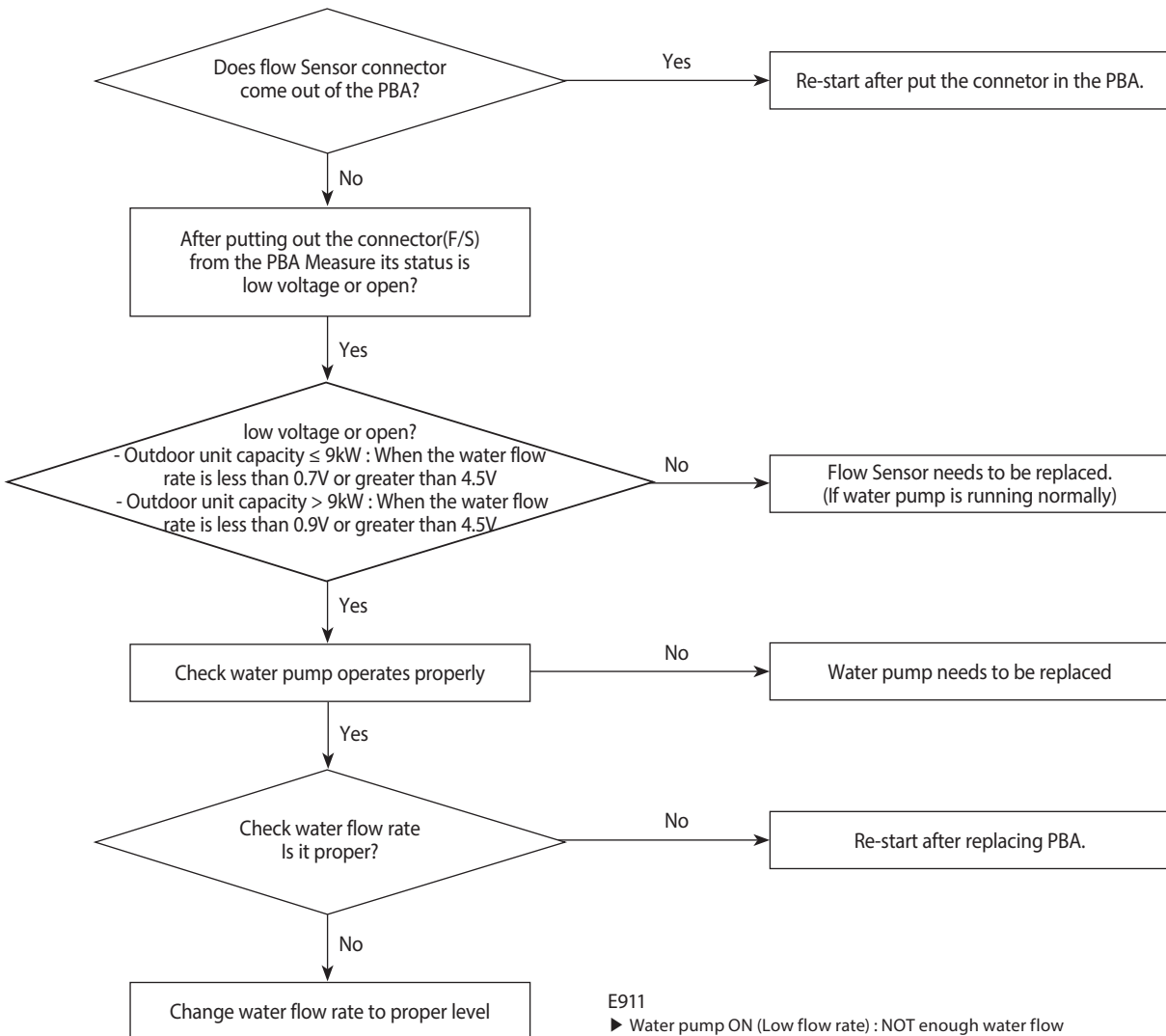

**E911**

▶ Water pump ON (Low flow rate) : NOT enough water flow

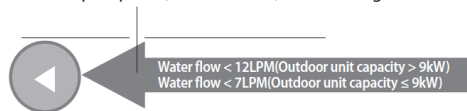

▶ Water flow range

	Water flow rates (LPM)	
	Min	Max
Outdoor unit capacity ≤ 9kW	7	48
Outdoor unit capacity > 9kW	12	58



2 Table for Water flow rate

DC Voltage	Water flow rate	DC Voltage	Water flow rate
0.50	1.2	2.70	44.5
0.55	2.1	2.75	45.5
0.60	3.1	2.80	46.5
0.65	4.1	2.85	47.4
0.70	5.1	2.90	48.4
0.75	6.1	2.95	49.4
0.80	7.1	3.00	50.4
0.85	8.0	3.05	51.4
0.90	9.0	3.10	52.4
0.95	10.0	3.15	53.4
1.00	11.0	3.20	54.3
1.05	12.0	3.25	55.3
1.10	13.0	3.30	56.3
1.15	14.0	3.35	57.3
1.20	14.9	3.40	58.3
1.25	15.9	3.45	59.3
1.30	16.9	3.50	60.3
1.35	17.9	3.55	61.2
1.40	18.9	3.60	62.2
1.45	19.9	3.65	63.2
1.50	20.9	3.70	64.2
1.55	21.8	3.75	65.2
1.60	22.8	3.80	66.2
1.65	23.8	3.85	67.1
1.70	24.8	3.90	68.1
1.75	25.8	3.95	69.1
1.80	26.8	4.00	70.1
1.85	27.7	4.05	71.1
1.90	28.7	4.10	72.1
1.95	29.7	4.15	73.1
2.00	30.7	4.20	74.0
2.05	31.7	4.25	75.0
2.10	32.7	4.30	76.0
2.15	33.7	4.35	77.0
2.20	34.6	4.40	78.0
2.25	35.6	4.45	79.0
2.30	36.6	4.50	80.0
2.35	37.6	4.55	80.9
2.40	38.6	4.60	81.9
2.45	39.6	4.65	82.9
2.50	40.6	4.70	83.9
2.55	41.5		
2.60	42.5		
2.65	43.5		

### 4-3-3 Water pump & Flow Sensor error

Wired remote display	E9 12
Criteria	• Refer to how to determine below
Cause of problem	Normal flow rate error • In case of normal flow rate in 10min during water pump signal is OFF

- How to check  
\* Water pump is detected only during stop

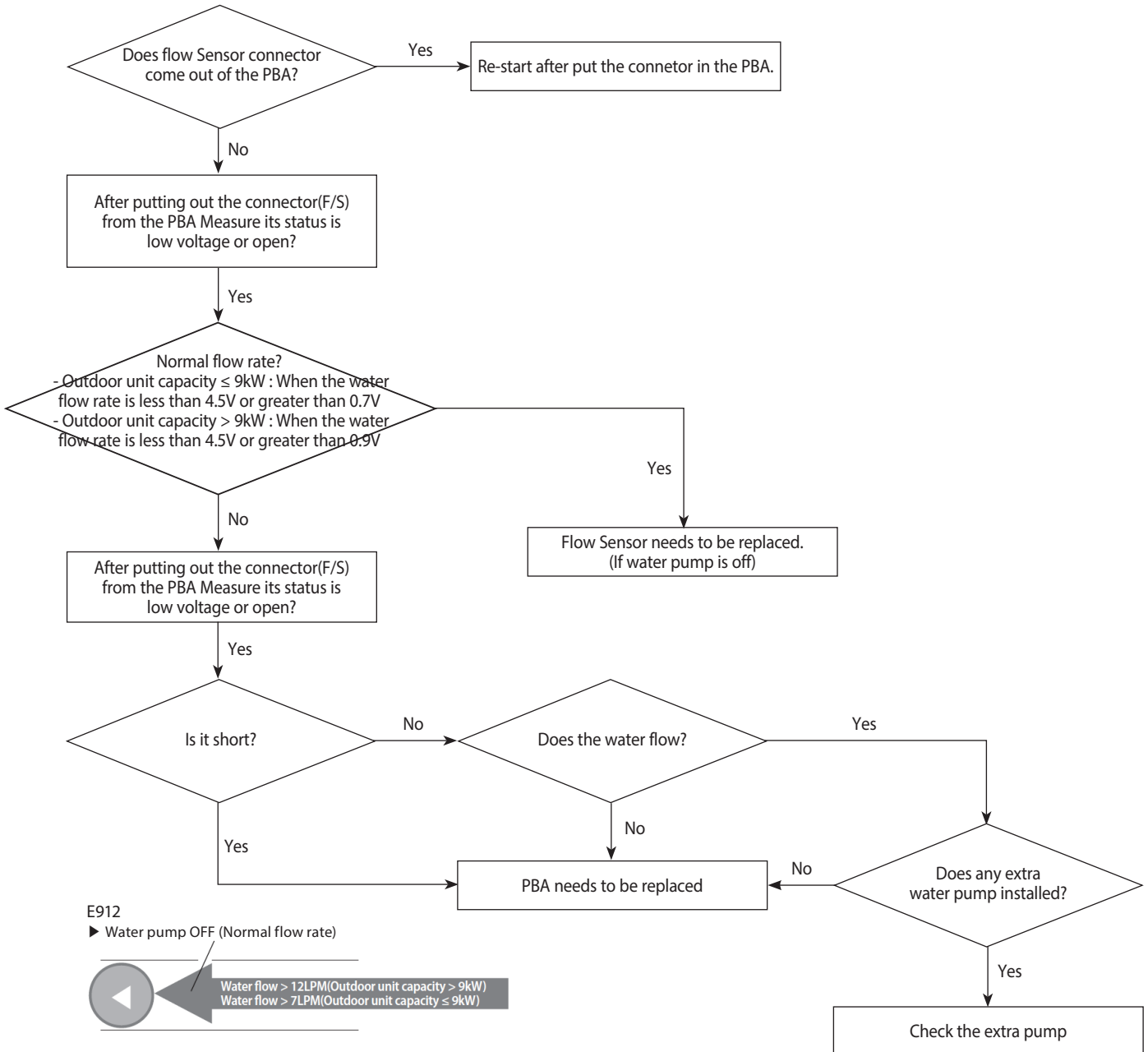

E912

▶ Water pump OFF (Normal flow rate)



Water flow > 12LPM(Outdoor unit capacity > 9kW)  
Water flow > 7LPM(Outdoor unit capacity ≤ 9kW)

▶ Water flow range

	Water flow rates (LPM)	
	Min	Max
Outdoor unit capacity ≤ 9kW	7	48
Outdoor unit capacity > 9kW	12	58

### 4-3-4 Hydro unit temperature sensor(open/short)

<b>Error Mode</b>	E121,E122,E123, E901, E902, E903, E904, E906, E916
<b>Symptom</b>	In case of open or short circuit of indoor temperature sensor
<b>Failure</b>	Short or leakage of the corresponding sensor

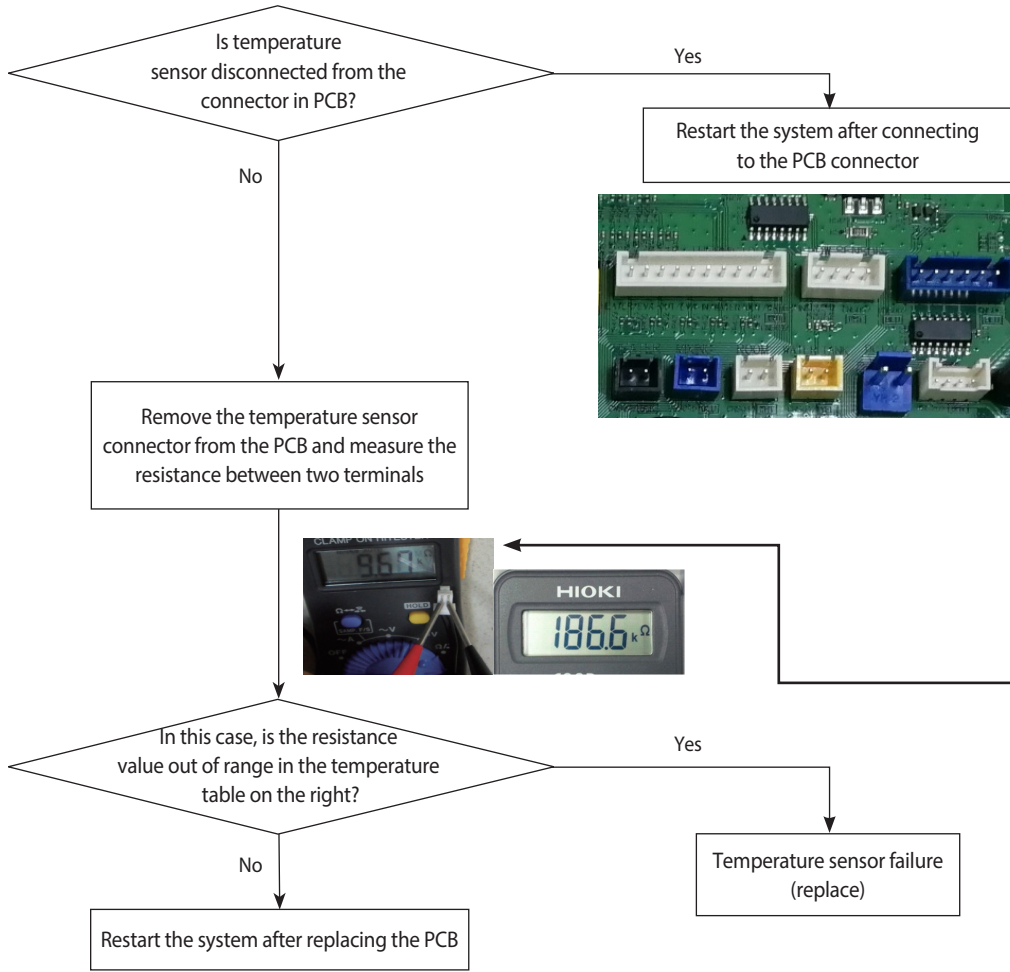

<204 Type>

Current temperature (°C)	Resistance (kΩ)
60	59.16
55	69.44
50	81.92
45	96.95
40	115.4
35	137.8
30	165.7
25	200
20	242.5
15	295.4
10	362.4

<103 Type>

Current temperature (°C)	Resistance (kΩ)
60	3.03
55	3.59
50	4.17
45	4.93
40	5.84
35	6.95
30	8.32
25	10
20	12.08
15	14.68
10	17.94

Error Mode	Sensor Type
E121,E122,E123, E901,E902,E903, E906,E916	103
E904	204

### 4-3-5 Communication error after finishing Tracking(Hydro unit)

<b>Error Mode</b>	E201, E202
<b>Symptom</b>	Communication error between the Hydro unit and outdoor unit for two minutes
<b>Failure</b>	Communication error between the Hydro unit unit and outdoor unit

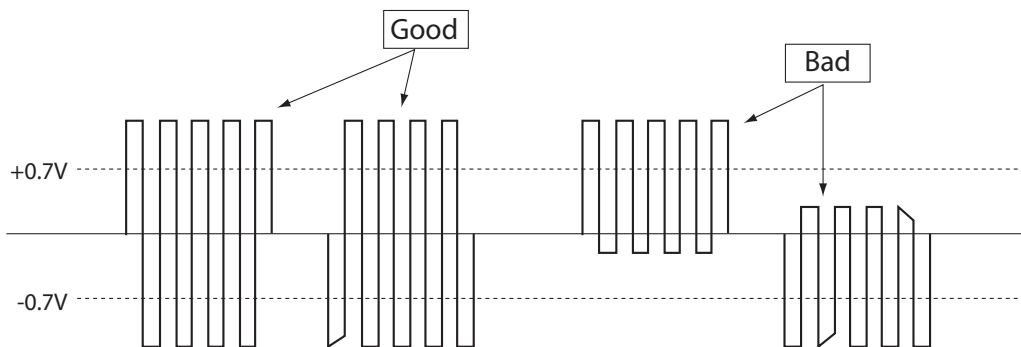
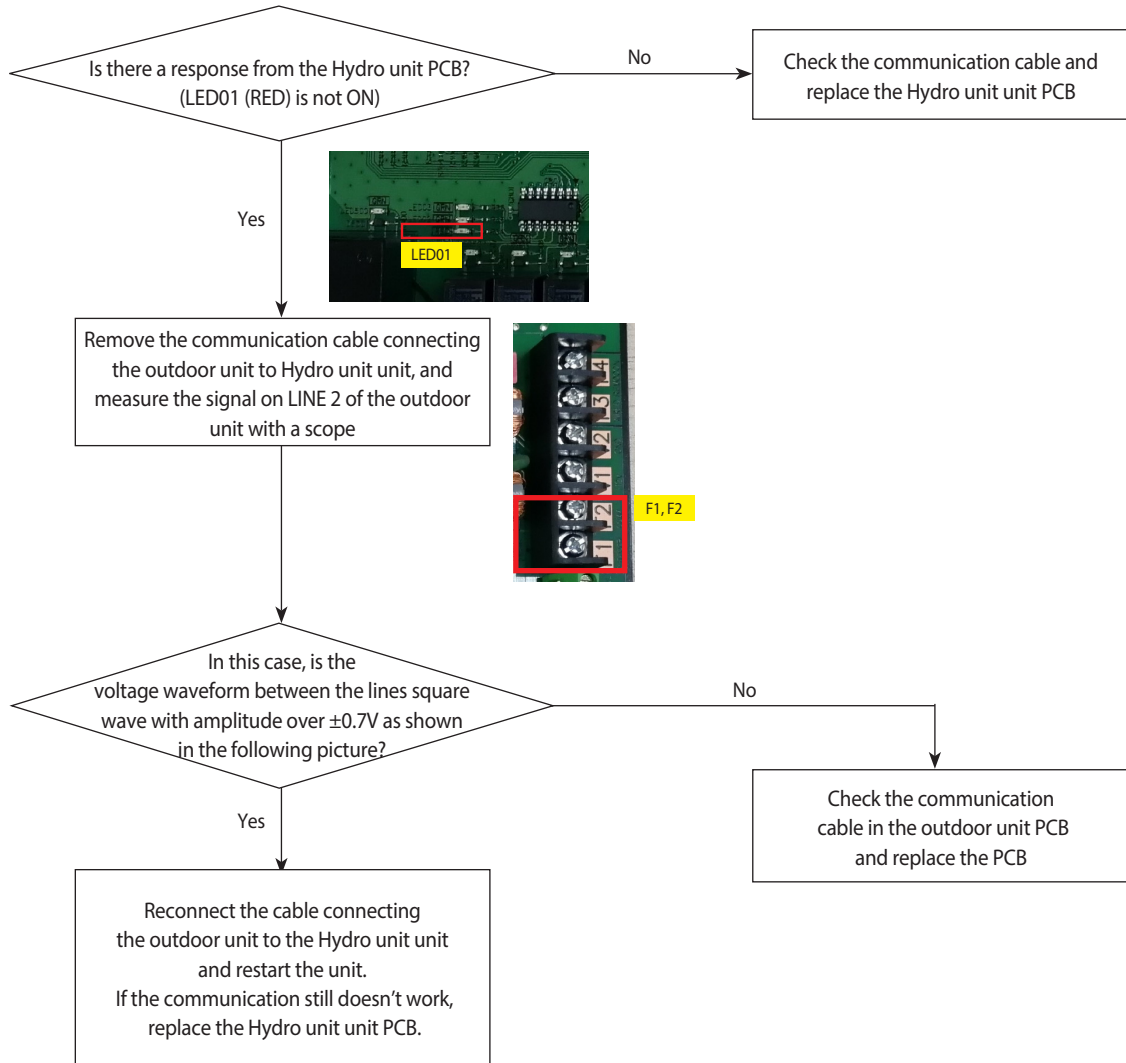

## 4-4 Items to check before diagnostics

### 4-4-1 Test run mode and view mode

#### Display Option Key

KEY	KEY operation	7-segment display
K1	Press once : Heating test run	"F" "1" "BLANK" "BLANK"
	Press twice : Defrost test run	"F" "3" "BLANK" "BLANK"
	Press 3times : Finishing test mode	-
K2	Press once : Cooling test run (Heating Only : skip)	"F" "2" "BLANK" "BLANK"
	Press twice : Output signal test run	"F" "4" "BLANK" "BLANK"
	Press 3 times : Finishing test mode	-
K3	Reset	-
K4	View mode	Refer to View mode display

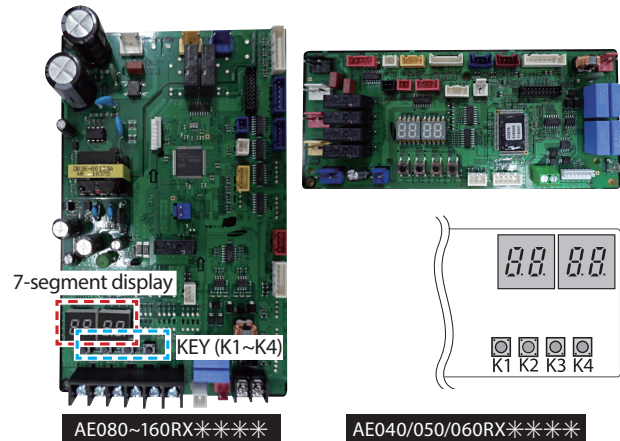

#### VIEW mode display

Number of press	Display contents	Display				Units
		Segment 1	Segment 2	Segment 3	Segment 4	
0	Communication State	10s digit of Tx	1s digit of Tx	10s digit of Rx	1s digit of Rx	-
1	Order frequency	1	100s digit	10s digit	1s digit	Hz
2	Current frequency	2	100s digit	10s digit	1s digit	Hz
3	Pump output	3	100s digit	10s digit	1s digit	%
4	Outdoor air sensor	4	+/-	10s digit	1s digit	°C
5	Discharge sensor	5	100s digit	10s digit	1s digit	°C
6	Eva in sensor (MONO)	6	+/-	10s digit	1s digit	°C
7	Inlet water sensor (MONO)	7	+/-	10s digit	1s digit	°C
8	Outlet water sensor (MONO)	8	+/-	10s digit	1s digit	°C
9	Cond sensor	9	+/-	10s digit	1s digit	°C
10	Current	A	10s digit	1s digit	First decimal	A
11	Fan RPM	B	1000s digit	100s digit	10s digit	rpm
12	Target discharge temperature	C	100s digit	10s digit	1s digit	°C
13	EEV	D	1000s digit	100s digit	10s digit	step
14	Protective control	E	0 : Cooling 1 : Heating	Protective control 0 : No protective control 1 : Freezing 2 : Defrosting 3 : Over-load 4 : Discharge 5 : Total current	Frequency status 0 : Normal 1 : Hold 2 : Down 3 : Up_limit 4 : Down_limit	-
15	IPM temp.	F	+/-	10s digit	1s digit	°C
long-1	Main Micom version	Year(Dec)	Month(Hex)	Day(two digit)	Day(One digit)	-
long-1 and 1	Inverter Micom version	Year(Dec)	Month(Hex)	Day(two digit)	Day(One digit)	-
long-1 and 2	EEPROM version	Year(Dec)	Month(Hex)	Day(two digit)	Day(One digit)	-

## 4-5 Troubleshooting by symptoms

### 4-5-1 Communication error after finishing tracking (E202)

1. Check items
  - 1) Is the communication cable short/open?
  - 2) Is there a response from the Hydro unit PCB?
2. Check procedure

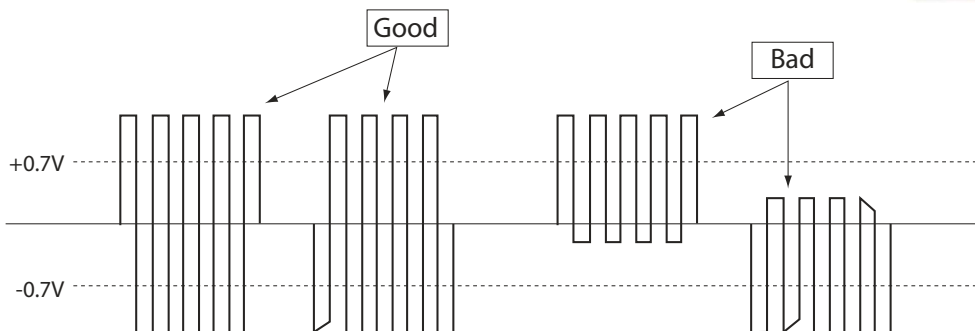
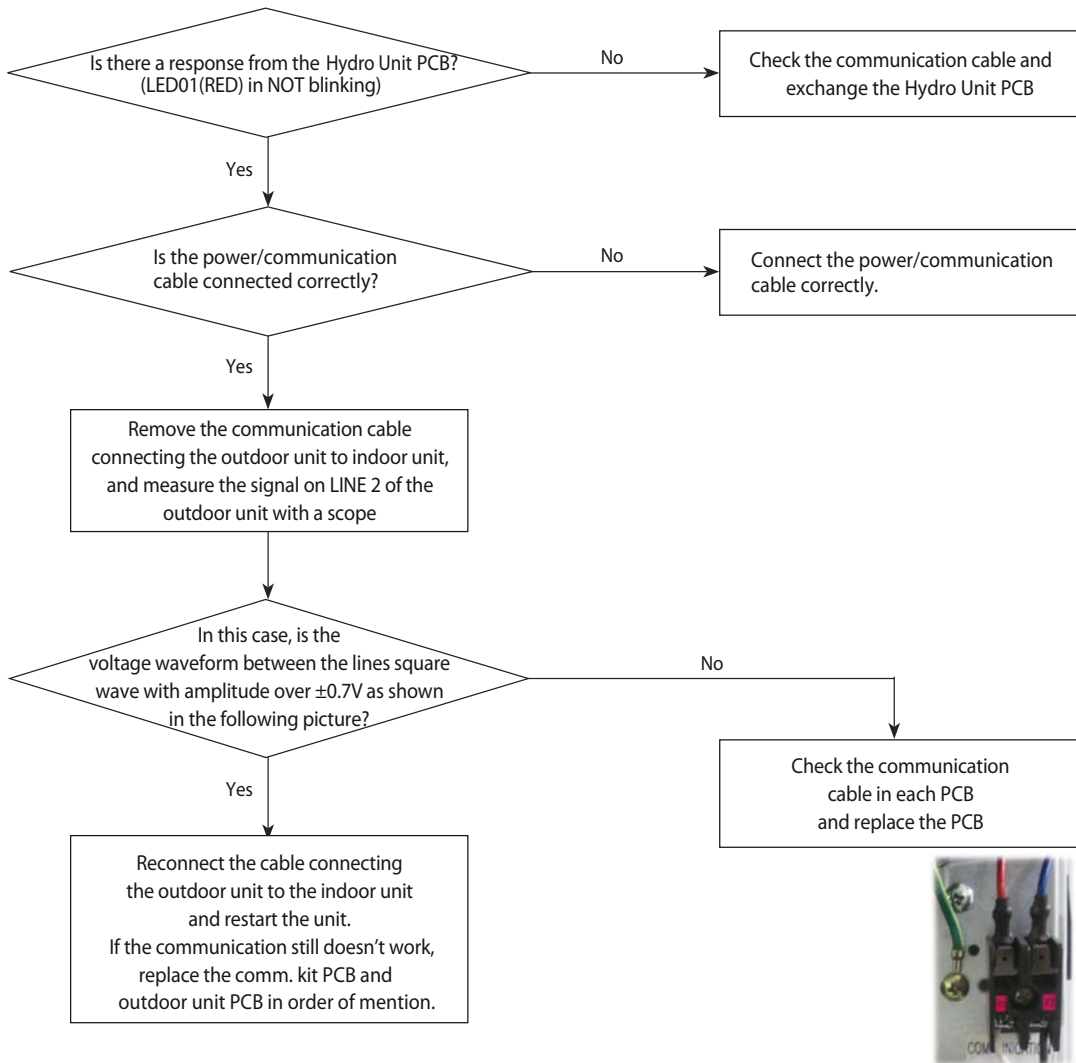

cf.) If there is no oscillo scope, it can be replaced multimeter instead of osillo scope.  
 If measured voltage is floating value from 0.1V to 4.5V, then it means that the PCB is normal.



### 4-5-2 Time out (1 min.) of communication error between MAIN PBA and INV. PBA (E203)

1. Check items
  - 1) Is the communication cable connected properly between MAIN PBA and INVERTER PBA?
  - 2) Is the power cable connected correctly?
2. Check procedure

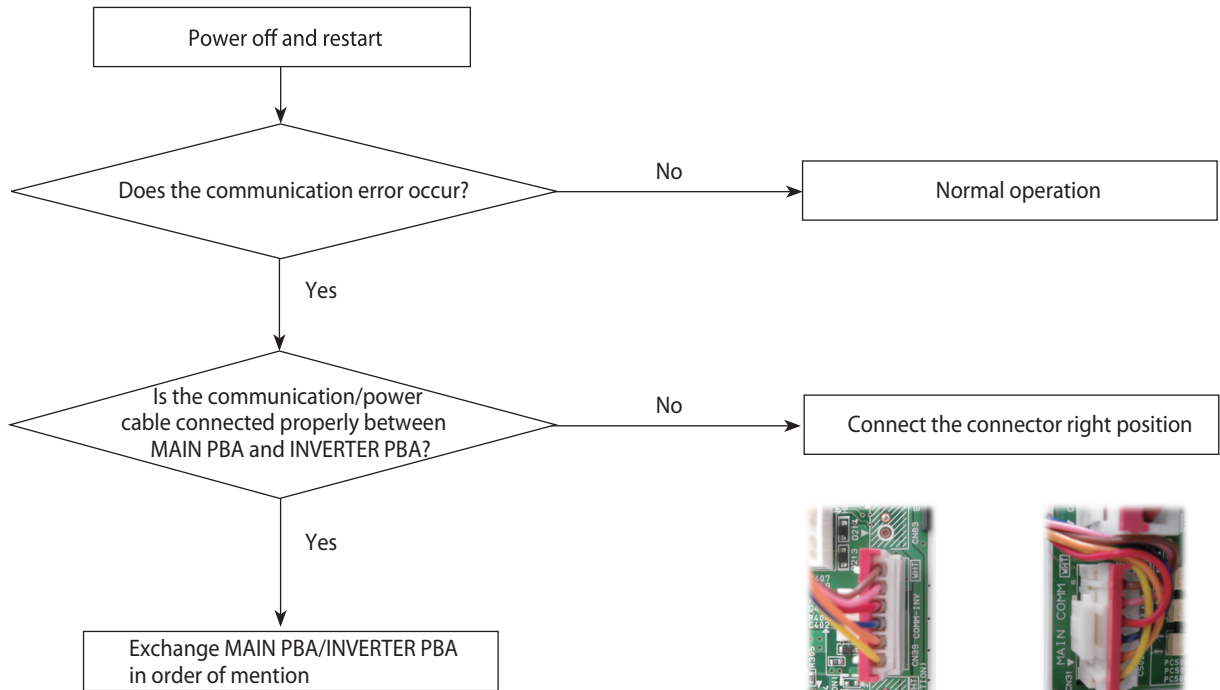

<CN305 in MAIN PBA > <CN31 in INVERTER PBA>

### 4-5-3 Temperature sensor error (E221, E231, E251, E320)

<Error code for each temperature sensor>

CN43 in MAIN PBA	Pin no.	Temp. sensor	Error code
	1,2	Outdoor	E221
	3,4	Condenser	E231
	5,6	Discharge	E251
	7,8	OLP	E320

1. Check items
  - 1) Is the sensor connected correctly (CN403 in MAIN PBA)?
  - 2) Is the position of sensor correct?
  - 3) Does the value of resistance satisfy the each temperature condition?

2. Check procedure

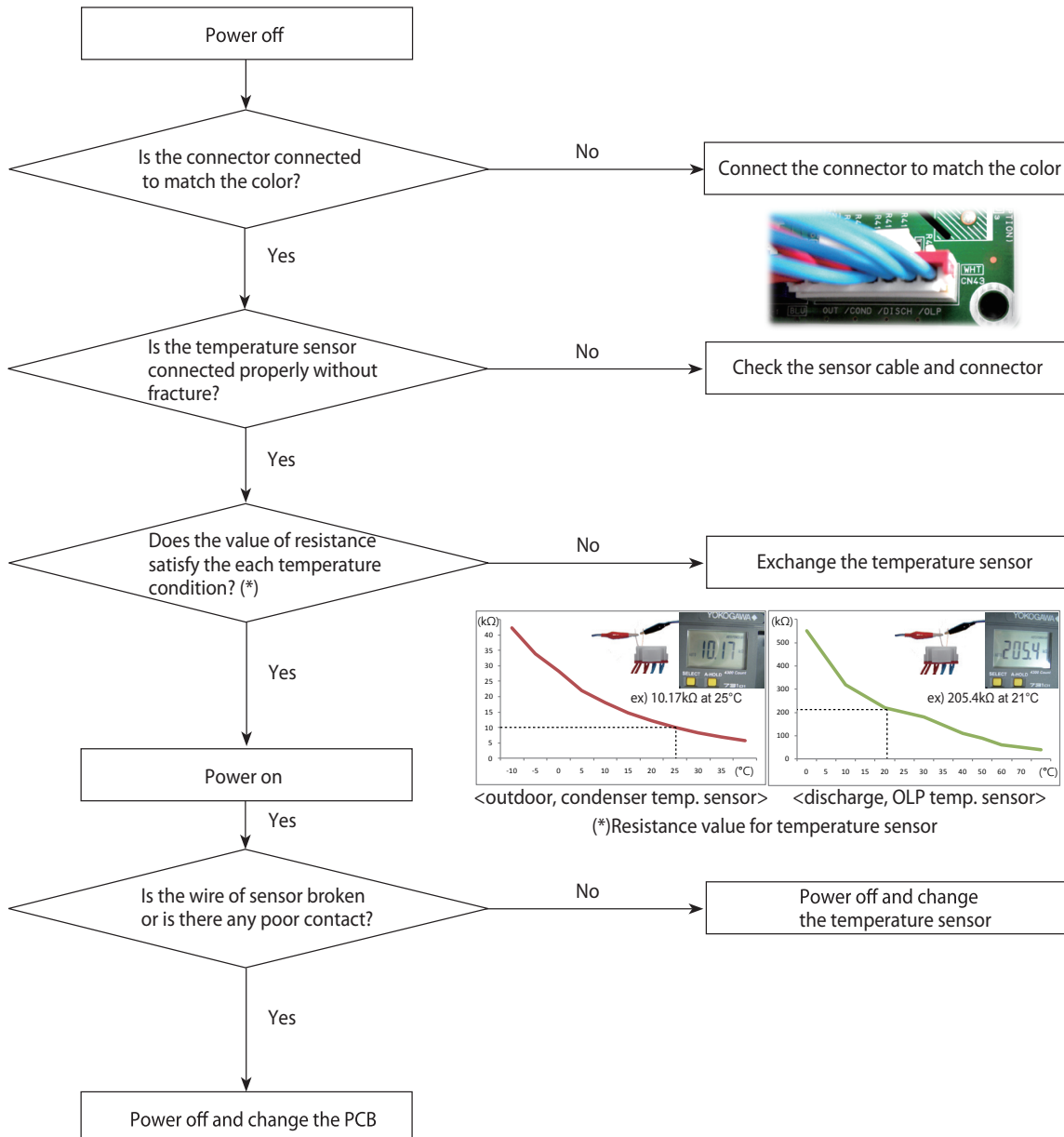

### 4-5-4 Fan error (E458, E475)

FAN 1 error(E458), FAN 2 error(E475)

1. Check items

- 1) Are the input power voltage and power connection correct?
- 2) Is the motor wire connected to the outdoor PCB correctly?
- 3) Is there no obstacle at the surrounding of motor and propeller?
- 4) Does the driver in the motor case broken?

2. Check procedure

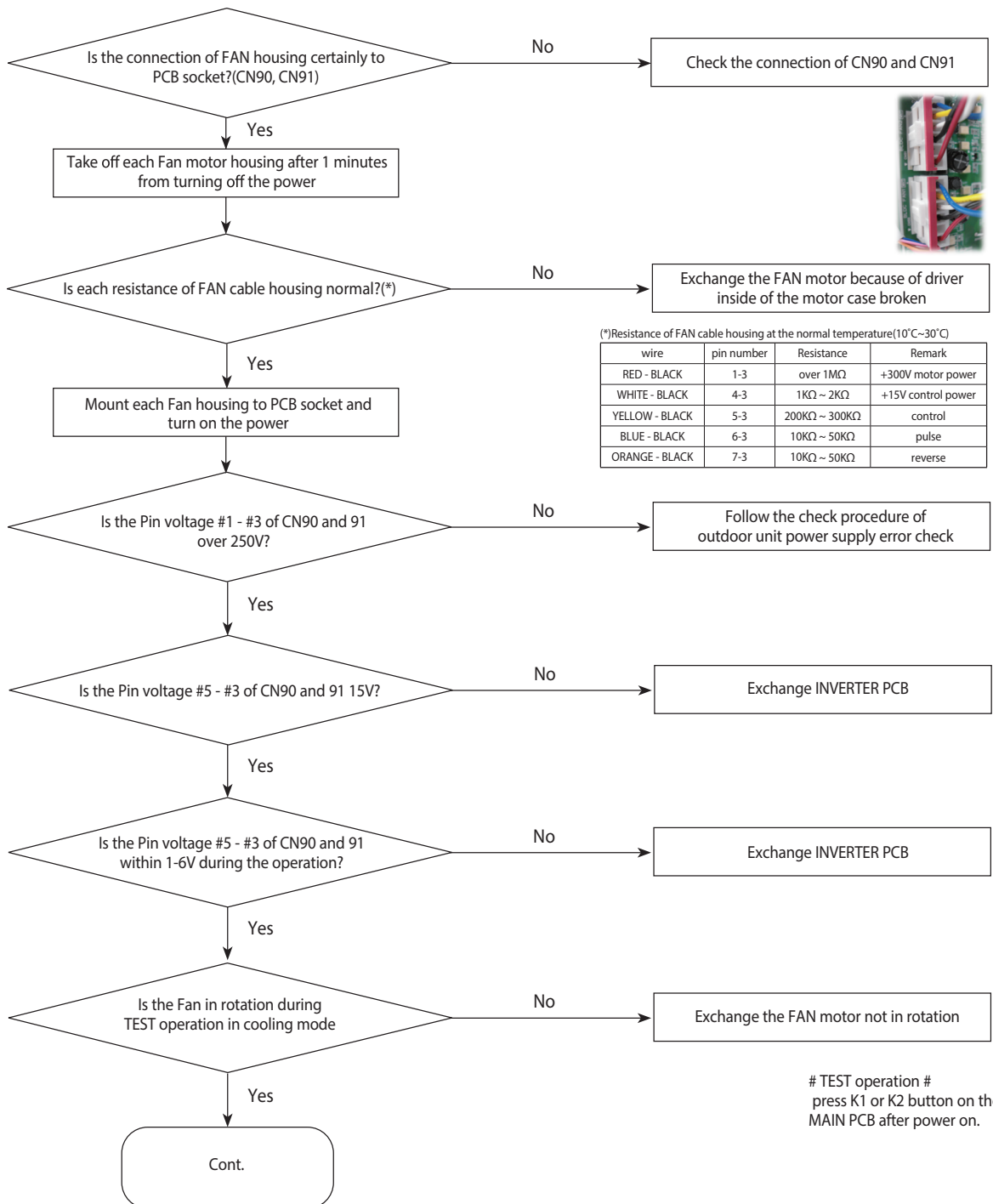

(\*)Resistance of FAN cable housing at the normal temperature(10°C~30°C)

wire	pin number	Resistance	Remark
RED - BLACK	1-3	over 1MΩ	+300V motor power
WHITE - BLACK	4-3	1KΩ ~ 2KΩ	+15V control power
YELLOW - BLACK	5-3	200KΩ ~ 300KΩ	control
BLUE - BLACK	6-3	10KΩ ~ 50KΩ	pulse
ORANGE - BLACK	7-3	10KΩ ~ 50KΩ	reverse

**Fan error (E458, E475) (cont.)**

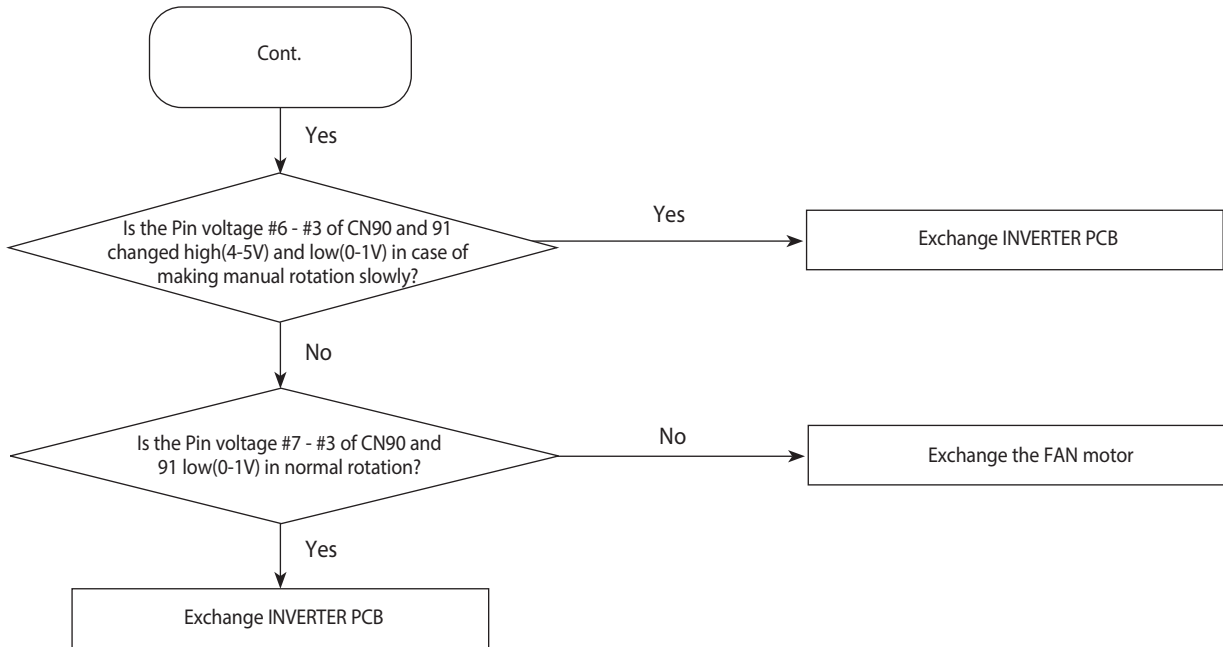

### 4-5-5 Compressor error (E461, E467)

Compressor starting error(E461), Compressor wire missing error(E467)

1. Check items
  - 1) Is the power connected properly?
  - 2) Is the connector of compressor connected correctly?
  - 3) Is the resistance normal between each phase for compressor ?
2. Check procedure

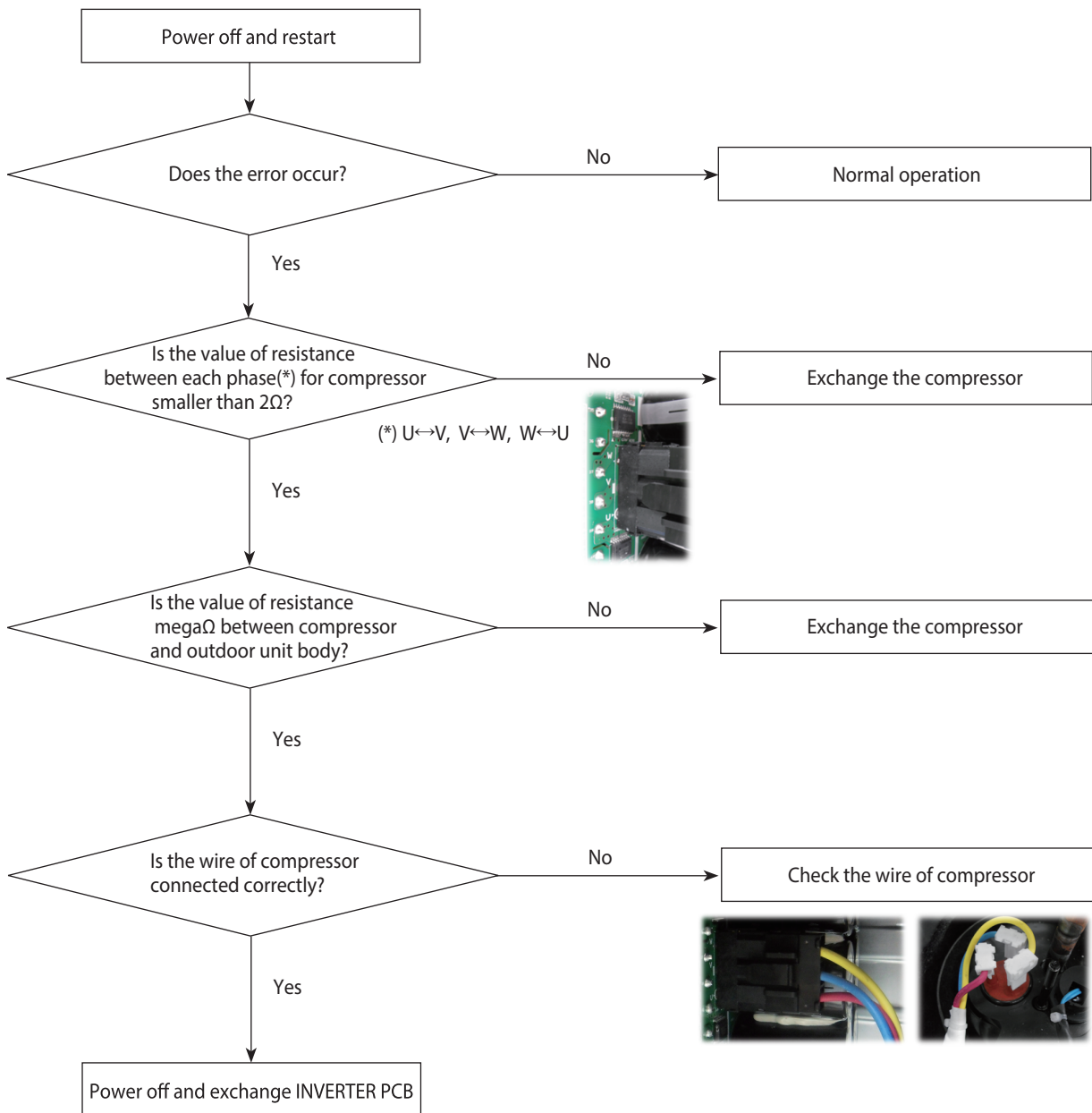

### 4-5-6 Current trip error (E462, E463)

Primary current trip error(E462), Over current trip / PFC over current error(E463)

1. Check items
  - 1) Is the voltage of power suitable?
  - 2) Is refrigerant charged?
  - 3) Does the fan of outdoor unit work normally?
  - 4) Is there any obstacle around indoor and outdoor unit?
2. Check procedure

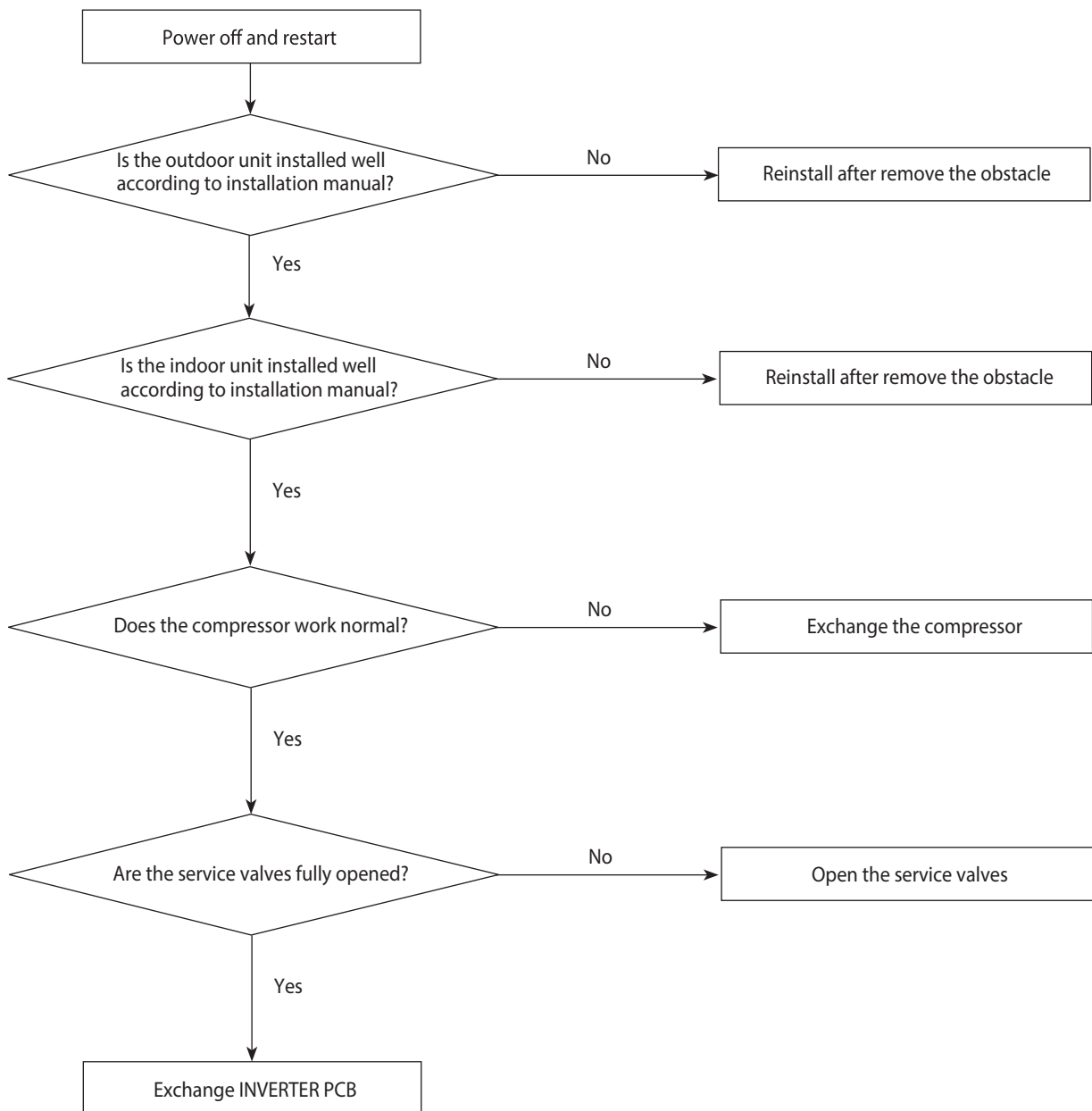



### 4-5-7 IPM(IGBT module) over current error (E464)

1. Check items
  - 1) Is refrigerant charged?
  - 2) Does the compressor work normally?
  - 3) Is the connection of compressor correctly?
  - 4) Is there any obstacle around indoor and outdoor unit?
2. Check procedure

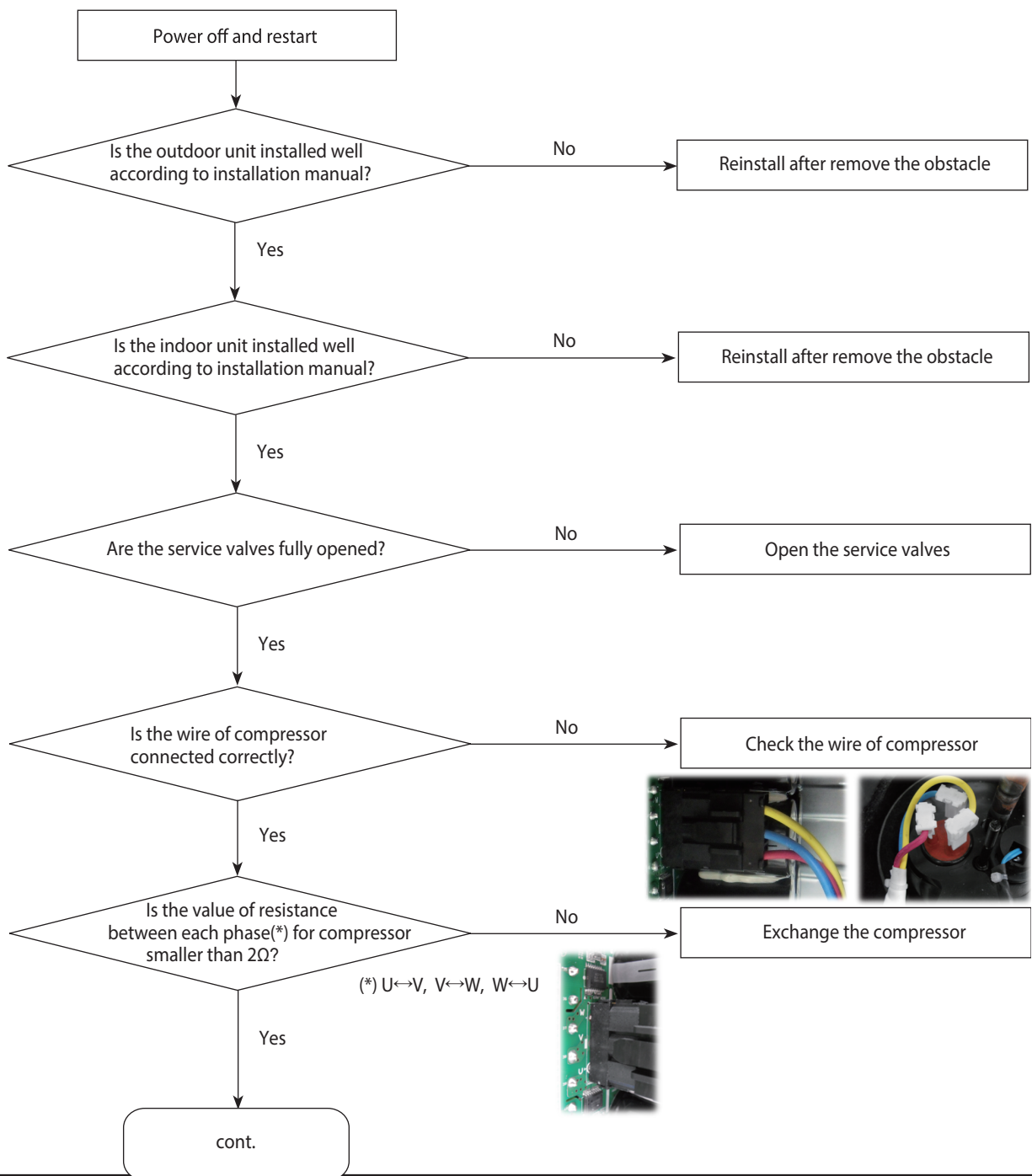

**IPM(IGBT module) over current error (E464) (cont.)**

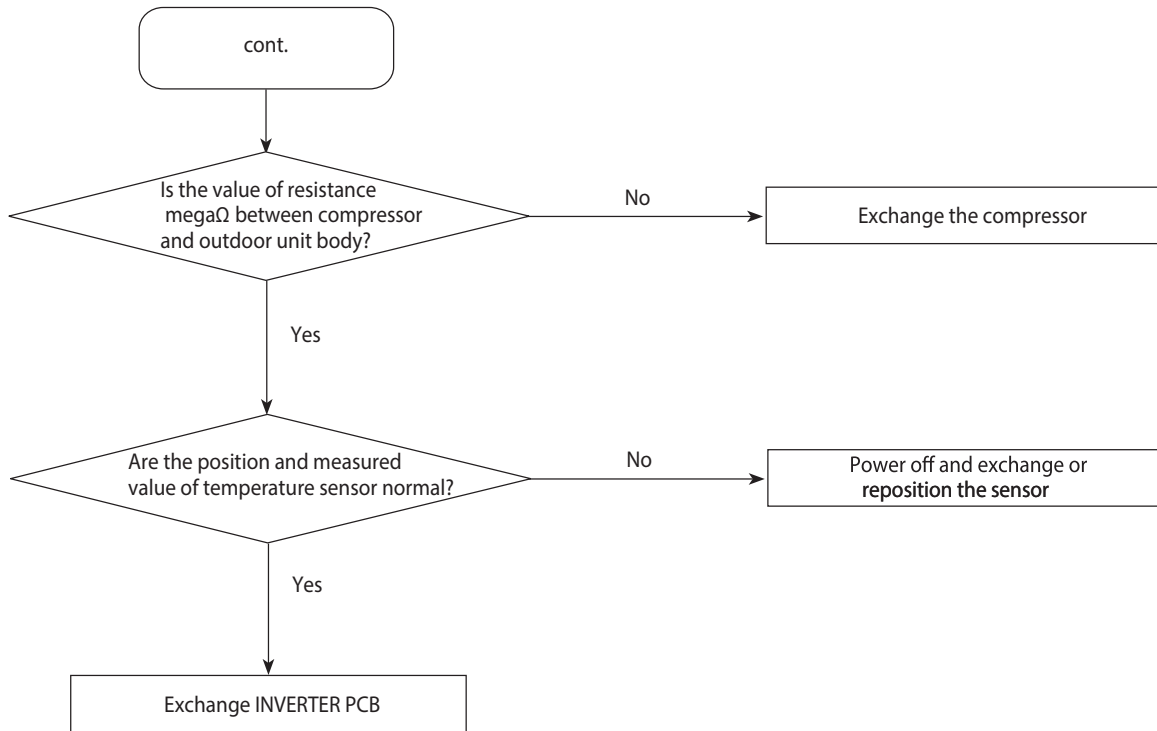

### 4-5-8 DC-link voltage under/over error (E466)

1. Check items
  - 1) Is the input power normal?
  - 2) Is the AC power connected correctly?
2. Check procedure

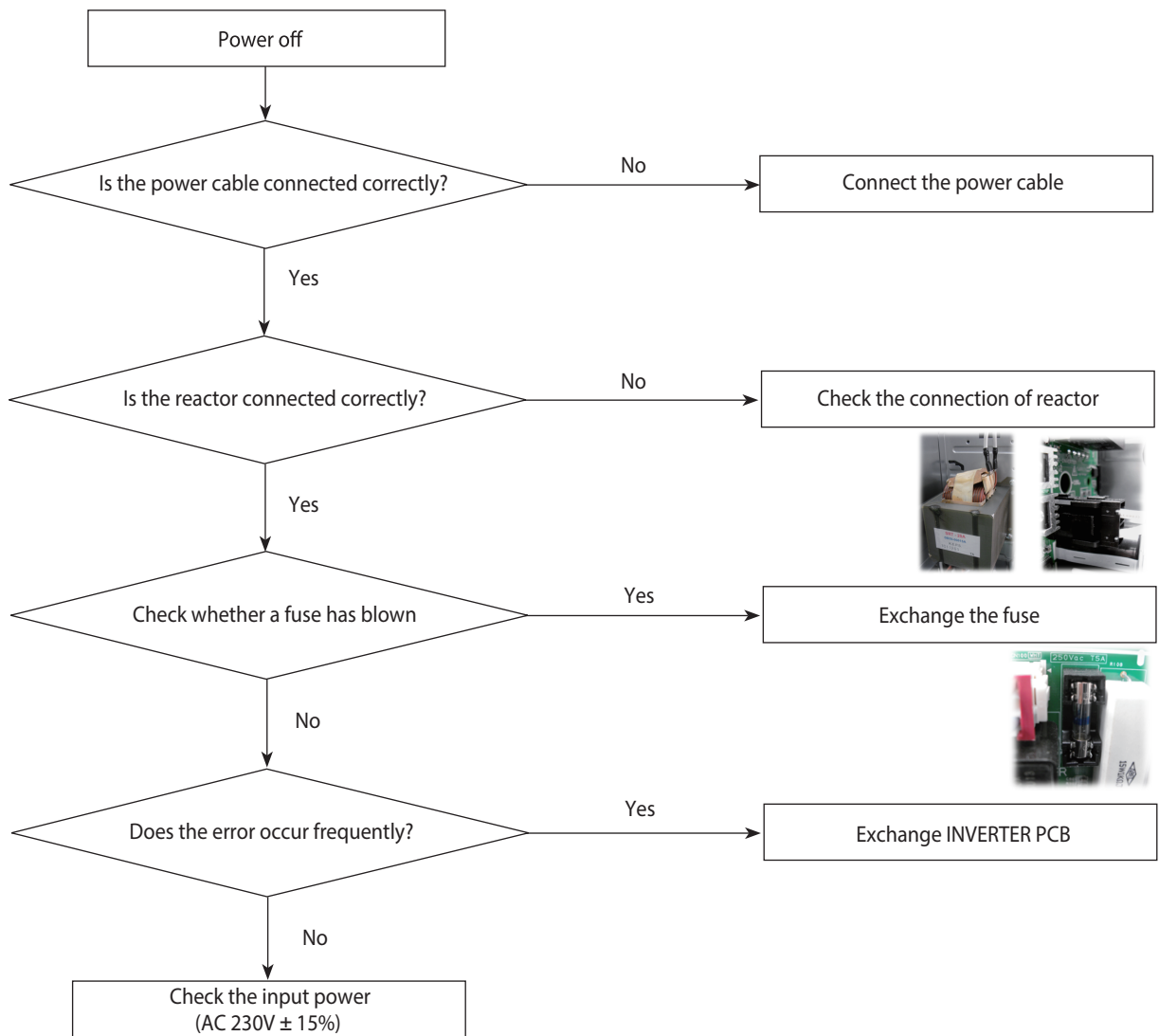

### 4-5-9 GAS leak error(E554)

1. Check items
  - 1) Is refrigerant charged?
  - 2) Is the evaporator sensor of indoor unit connected correctly?
2. Check procedure

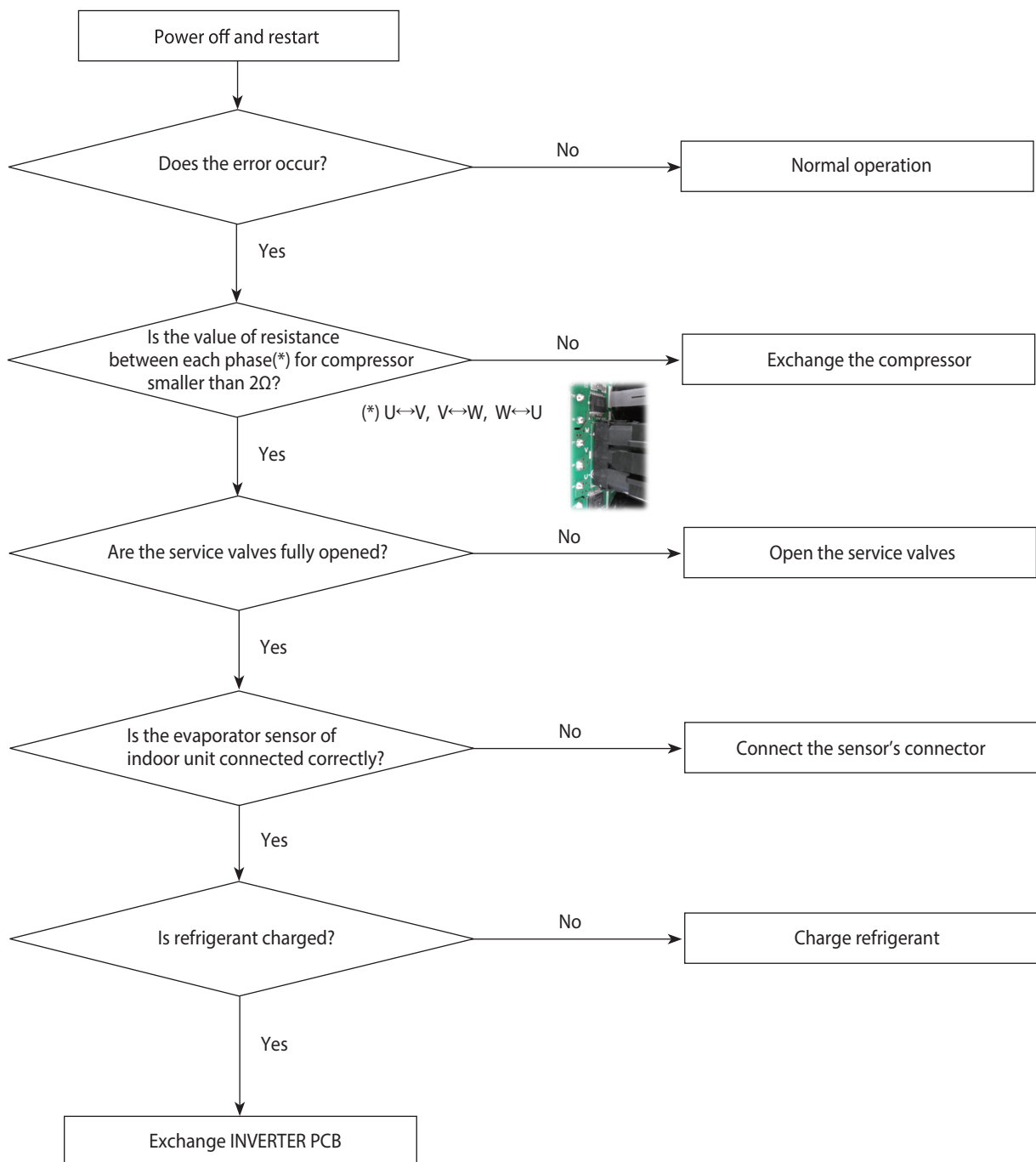

### 4-5-10 In case of heating at the cooling mode or cooling at the heating mode

1. Troubleshooting procedure

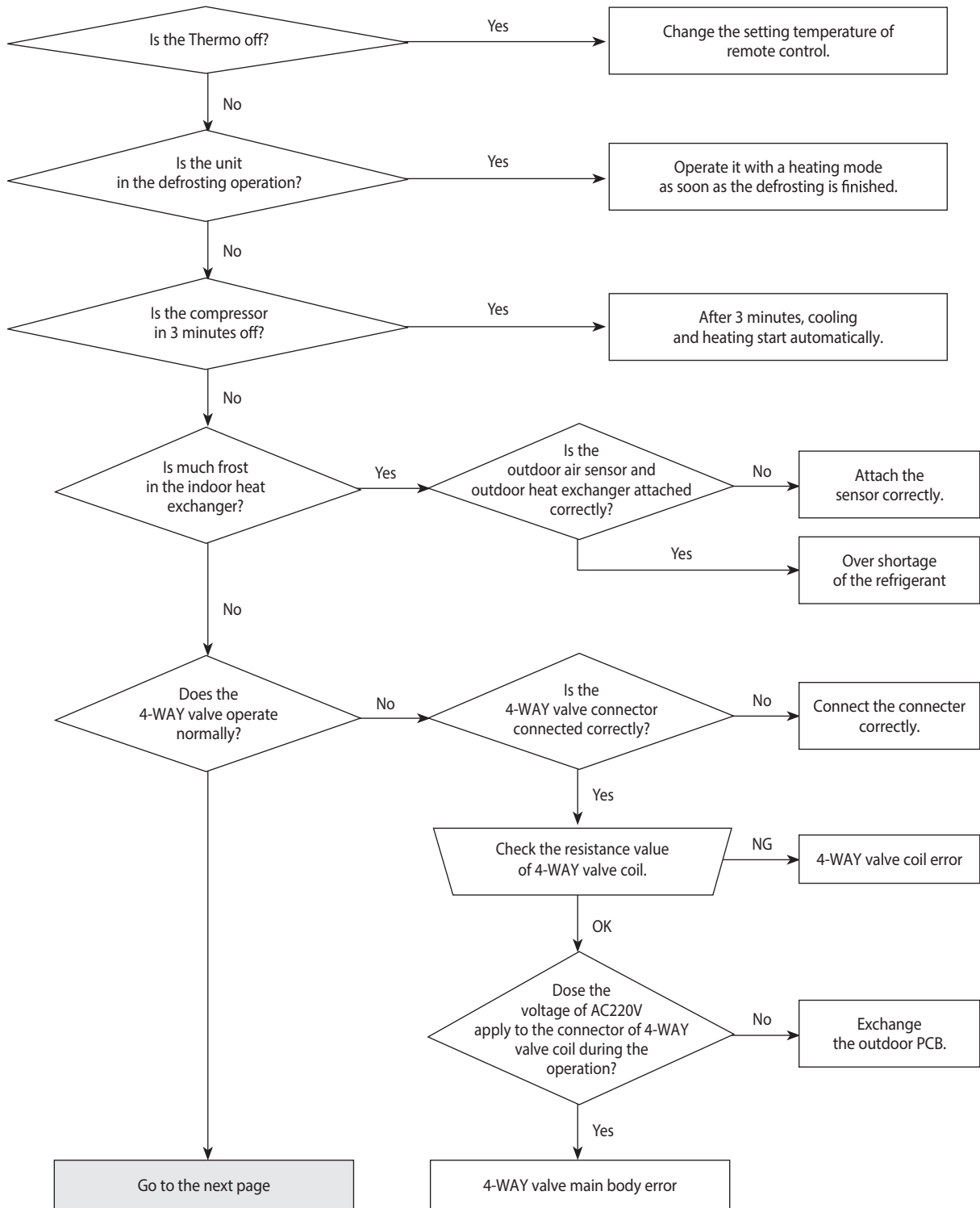

**In case of heating at the cooling mode or cooling at the heating mode (cont.)**

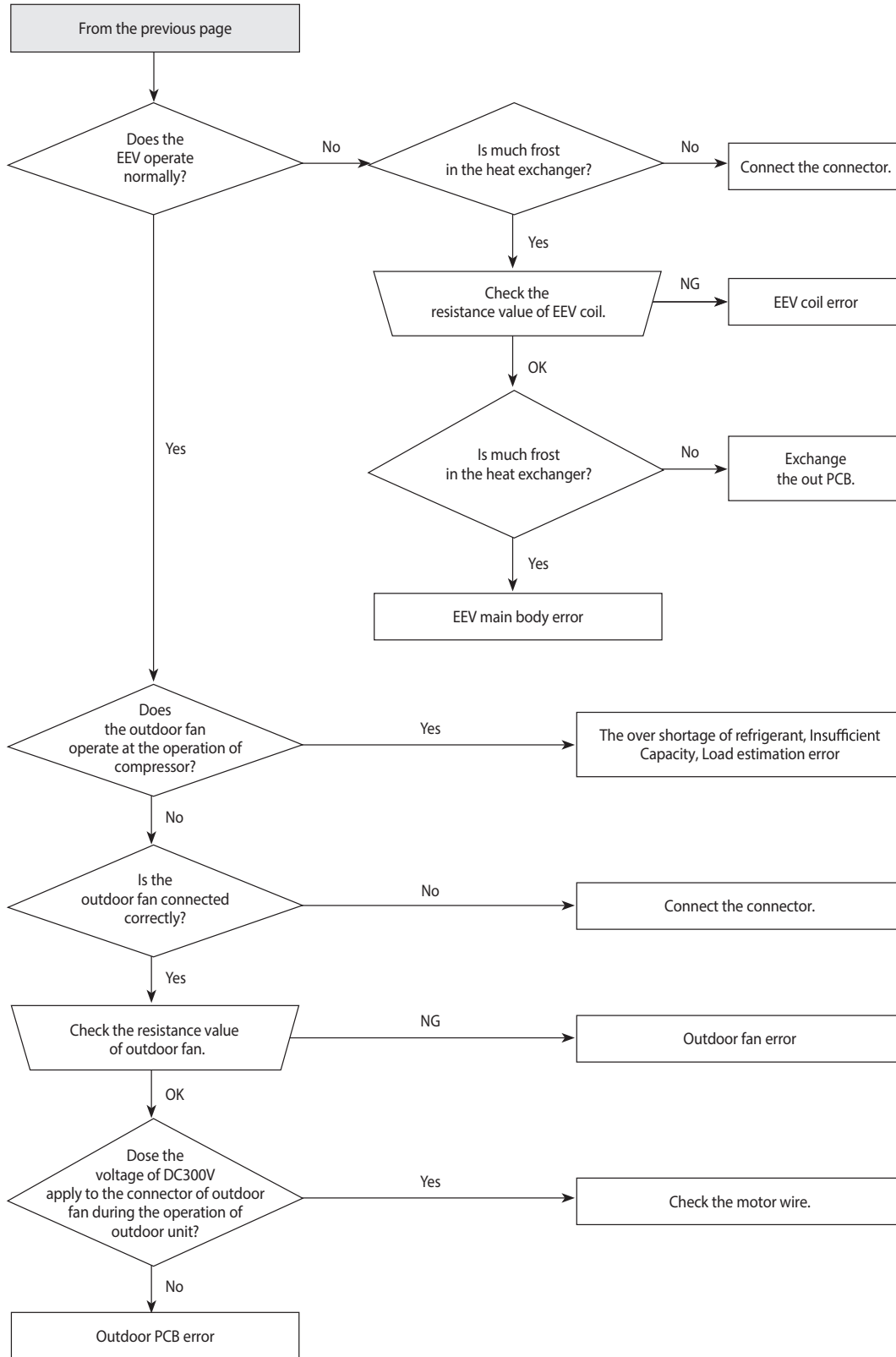

ormal resistance value of EEV valve coil(Red-Black or Yellow-Orange) :  $92 \pm 8\Omega$  (at 20°C)



### 4-5-11 Outdoor unit is not powerde on - Intial diagnosis

1. Check items
  - 1) Is the power supply voltage 380V?
  - 2) Is the AC power connected correctly?
  - 3) Are the LEDs in the main PCB and inverter PCB of the outdoor unit ON?
  - 4) Is the input power voltage of the indoor unit 220V?
  - 5) Is the wired remote controller connected correctly?
2. Check procedure

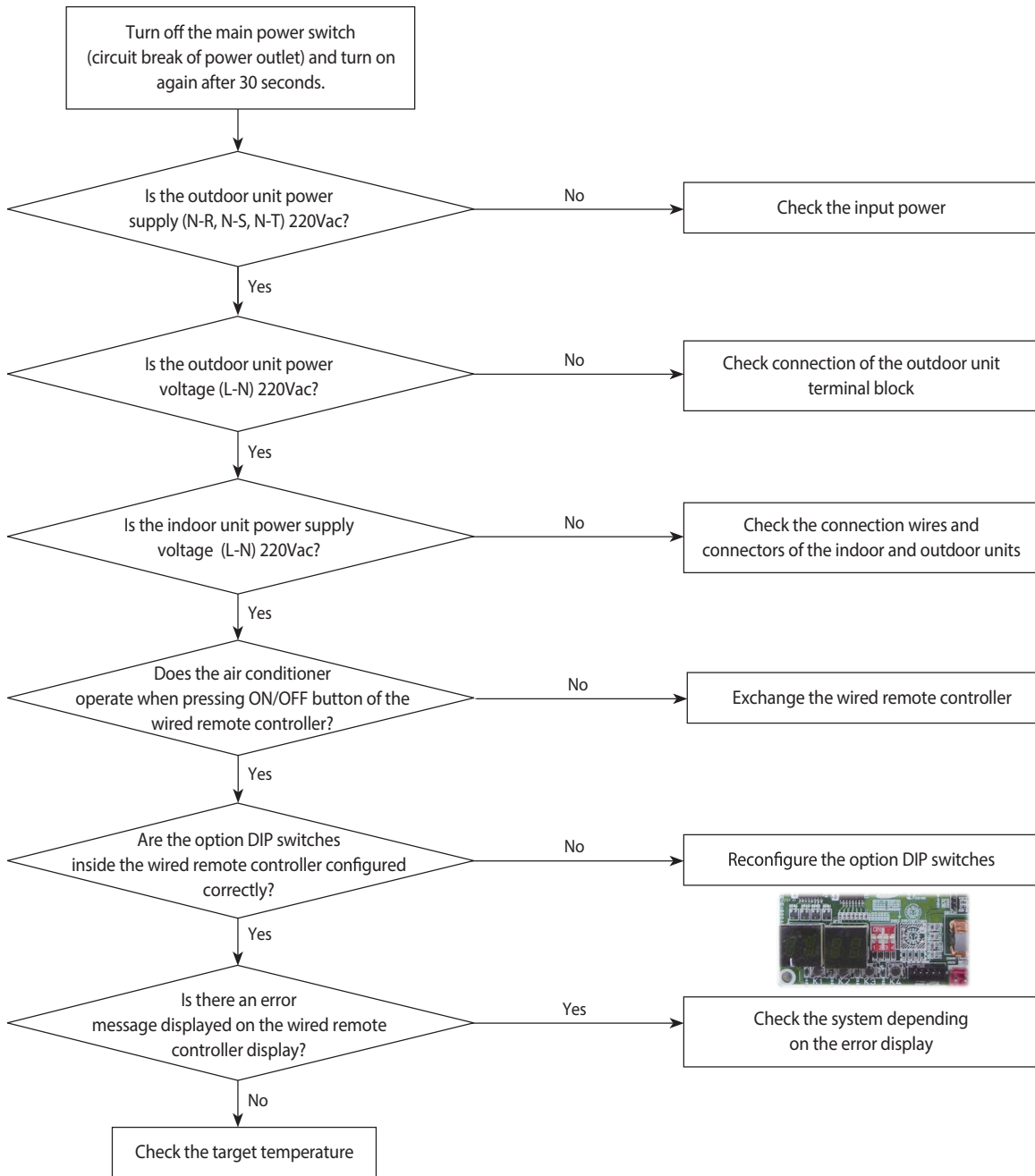

### 4-5-12 Outdoor unit power supply error

1. Checklist:
  - 1) Are the input power voltage and power connection correct?
  - 2) Is there any Fuse Short of the indoor or outdoor unit?
  - 3) Is any LED lit on both MAIN PCB and INVERTER PCB?
  - 4) Are Reactor wires of the outdoor unit connected correctly?

2. Troubleshooting procedure

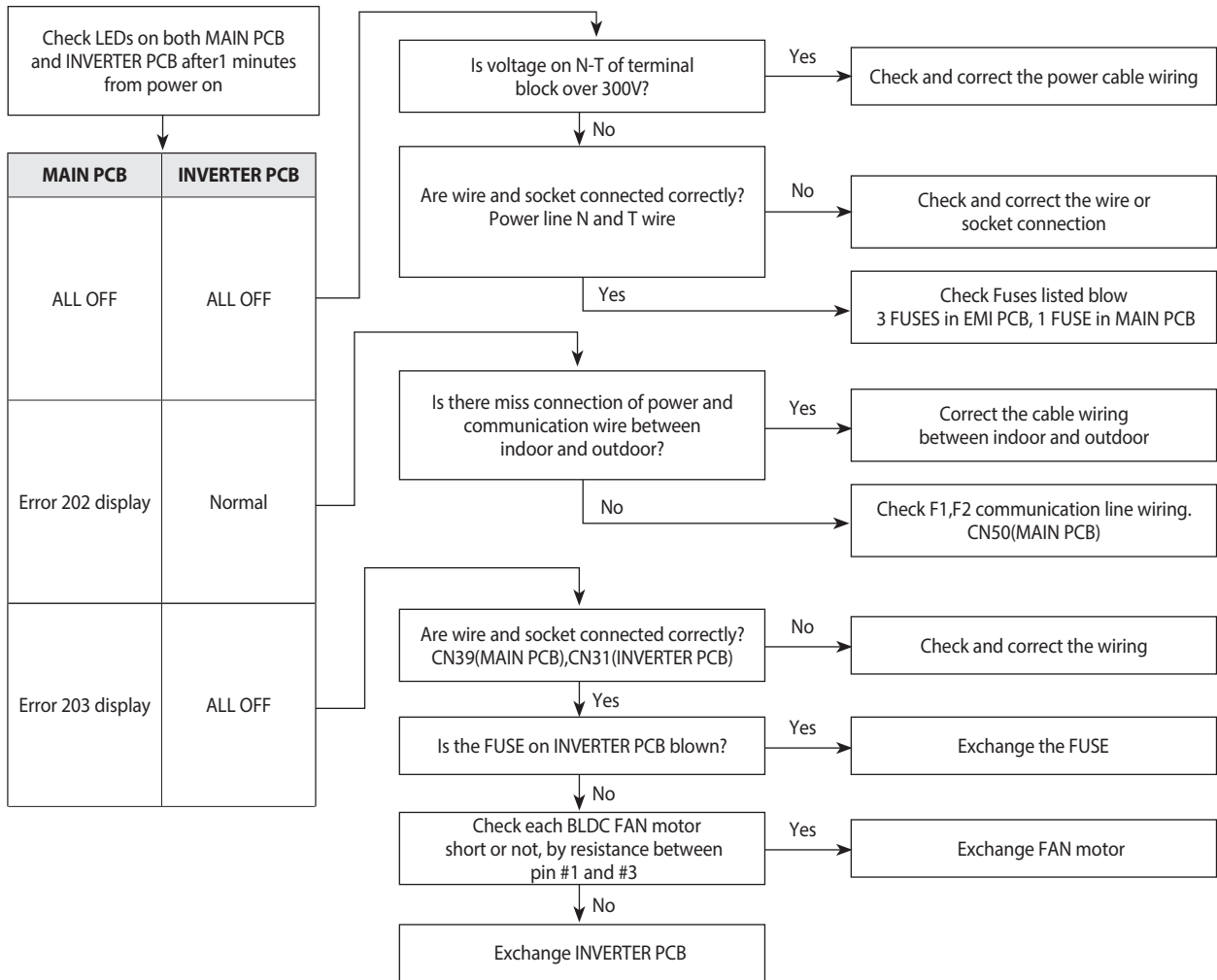

## 5. PCB Diagram

### 5-1 Tank Integrated Hydro Unit

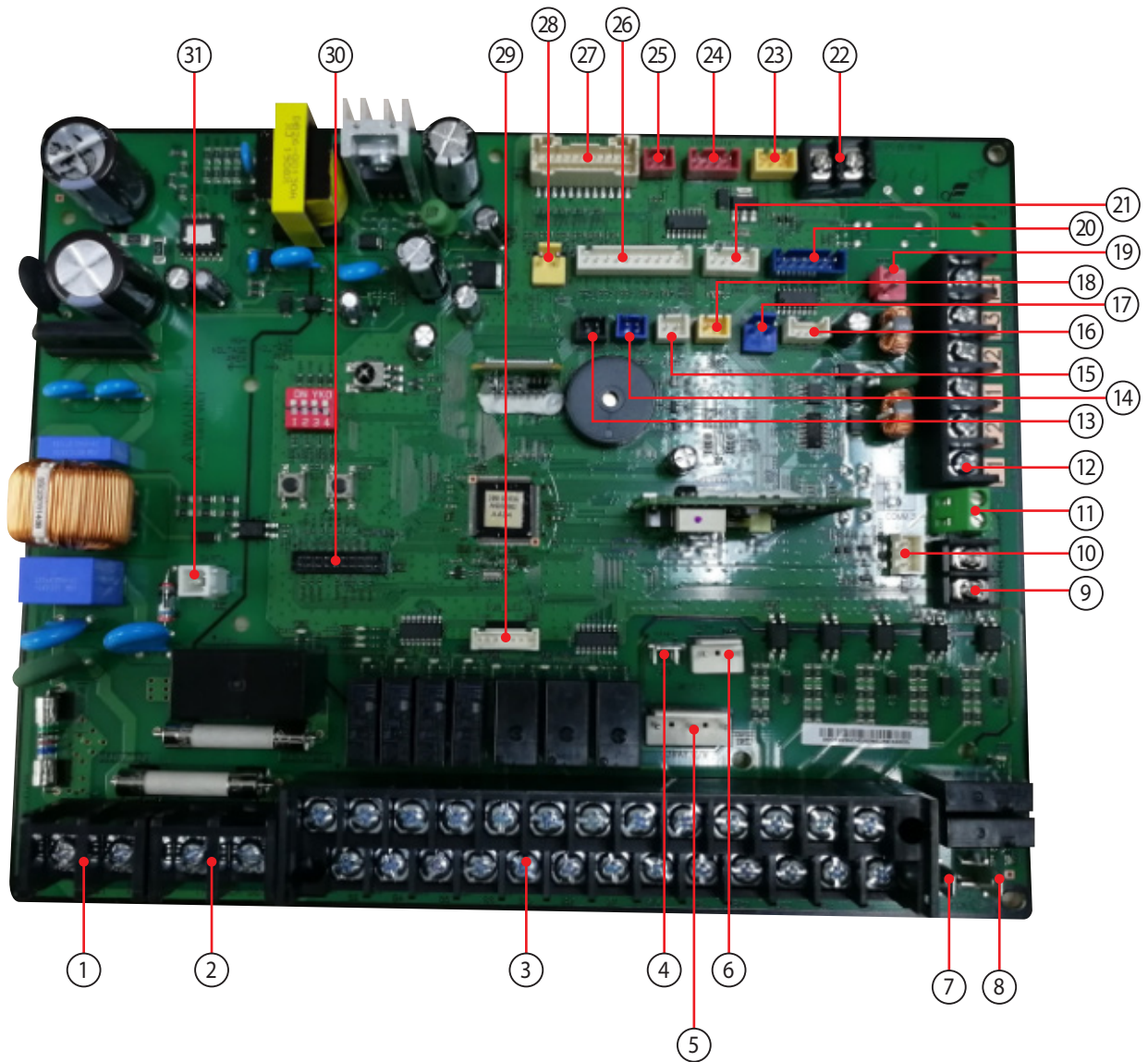

This Document can not be used without Samsung's authorization.

No.	Local	Function	Description
1	TB-A	MAIN POWER	DAPC 3013-2P BLK
2	TB-A1	BOOSTER&IMMERSION HEATER	DAPC 3013-2P BLK
3	TB-B	EXTERNAL CONTROL	BR-1000C2-26P BLK
4	CNP003	MC-COMMON	YTR250
5	CNP501	3-WAY VALVE	YW396-05AV WHT
6	CNP401	HEATER THERMOSTAT	YW396-03AV WHT
7	CNP002	MC2-A	YTR250
8	CNP001	MC1-A	YTR250
9	CNS002	WATER PUMP SIG/GND	BR-7623C-2P BLK
10	CNS001	WATER PUMP SIG/GND	SMW250-03 WHT
11	CNS003	FR CONTROL	AKZ350 GRN
12	TB-C	F1-F2/DC12V-GND/F3-F4	DAPC 2009-6P BLK
13	CNS047	HEATER SENSOR	SMW250-02 BLK
14	CNS045	MIXING VALVE SENSOR	SMW250-02 BLU
15	CNS044	ROOM SENSOR	SMW250-02 WHT
16	CNS202	F1-F2/GND-DC12V	SMW200-04 WHT
17	CNS012	DC12V	YW396-02V BLU
18	CNS042	WATER TANK SENSOR	SMW250-02 YEL
19	CNS304	F3-F4	YW396-02V RED
20	CNS063	EEV	SMW250-06 BLU
21	CNS057	FLOW SENSOR	SMW250-04 WHT
22	CNS046	PV SIGNAL(SMART GRID)	BR-7623C-2P BLK
23	CNS808	DC FAN	SMW250-03 YEL
24	CNS081	ERROR/COMP CHECK	SMW250-04 RED
25	CNS083	EXTERNAL CONTROL	SMW250-02 RED
26	CNS043	HEATER/EVA-OUT/EVA-IN/ WATER-OUT/WATER-IN SENSOR	SMW250-10 WHT
27	CNS051	EXTERNAL CONTROL/SENSOR	WB20L-024-132 WHT
28	CNS041	FLOW SWITCH	YW396-02V YEL
29	CNS201	SUB_LED	SMW200-07 WHT
30	CNS301	DOWNLOAD	YDW200-20 BLK
31	CNP101	EARTH	YDW236-01 WHT

## 5-2 Outdoor Unit

### MAIN PCB (AE080/090/120/160RX\*\*\*\*)

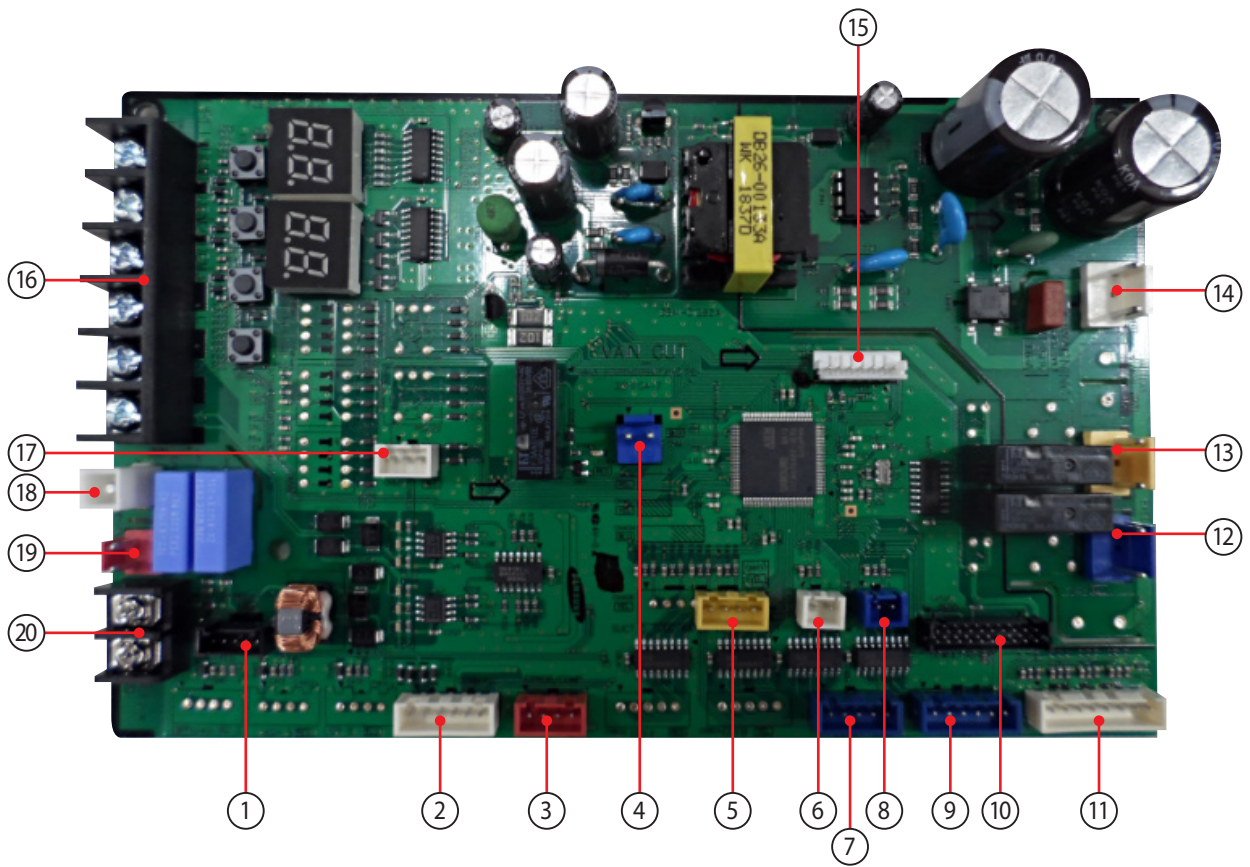

This Document can not be used without Samsung's authorization.

No.	Local	Function	Description
1	CN302	COMM-OPTION	SMW200-05 BLK
2	CN305	COMM INV	SMW250-06 WHT
3	CN801	ERROR/COMP CHECK	SMW250-04 RED
4	CN12	DC12V	YW396-02V BLU
5	CN407	WATER-IN/OUT	SMW250-04 YEL
6	CN001	EVA-IN	SMW250-02 WHT
7	CN803	EEV1	SMW250-05 BLU
8	CN407	HIGH PRESSURE SWITCH	SMW250-02 BLU
9	CN802	EEV4	SMW250-06 BLU
10	CN306	DOWNLOAD	YDW200-20 BLK
11	CN403	OUT TEMP/COND/DISCHARGE/OLP	SMW250-10 WHT
12	CN703	BASE HEATER	YW396-03AV BLU
13	CN702	4WAY-1	YW396-03AV YEL
14	CN101	POWER	YW396-03AV WHT
15	CN806	EEPROM	B7P-MQ WHT
16	CN304	DRED	DAPC 2009-6P BLK
17	CN501	MODE SELECTOR	SMW250-03 WHT
18	CN103	EARTH	YDW236-01 WHT
19	CN303	COMM-INDOOR	YW396-02V RED
20	CN003	QUIET S/W	BR-7623-2P BLK



**INVERTER PCB**  
(AE090RX\*\*EG)

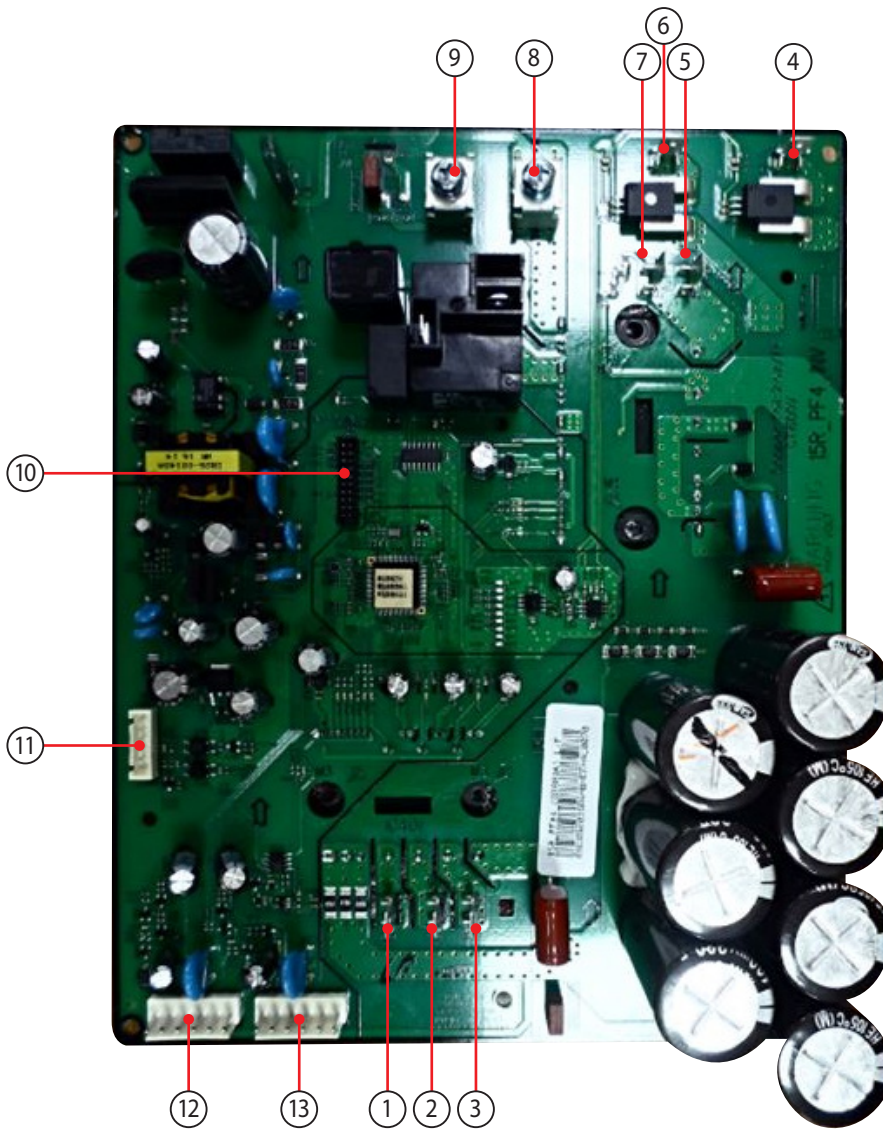

This Document can not be used without Samsung's authorization.

No.	Local	Function	Description
1	CN401	COMP U	YTR250
2	CN402	COMP V	YTR250
3	CN403	COMP W	YTR250
4	REACTOR_A2	REACTOR_A	YTR250
5	REACTOR_A1	REACTOR_A	YTR250
6	REACTOR_B2	REACTOR_B	YTR250
7	REACTOR_B1	REACTOR_B	YTR250
8	N	AC POWER	OT-048
9	L	AC POWER	OT-048
10	CN551	DOWNLOAD	YDW200-20 BLK
11	CN351	COMM	SMW250-06 WHT
12	CN901	FAN 1	YW396-06V WHT
13	CN911	FAN 2	YW396-06V WHT

## INVERTER PCB (AE120/160RX\*\*EG)

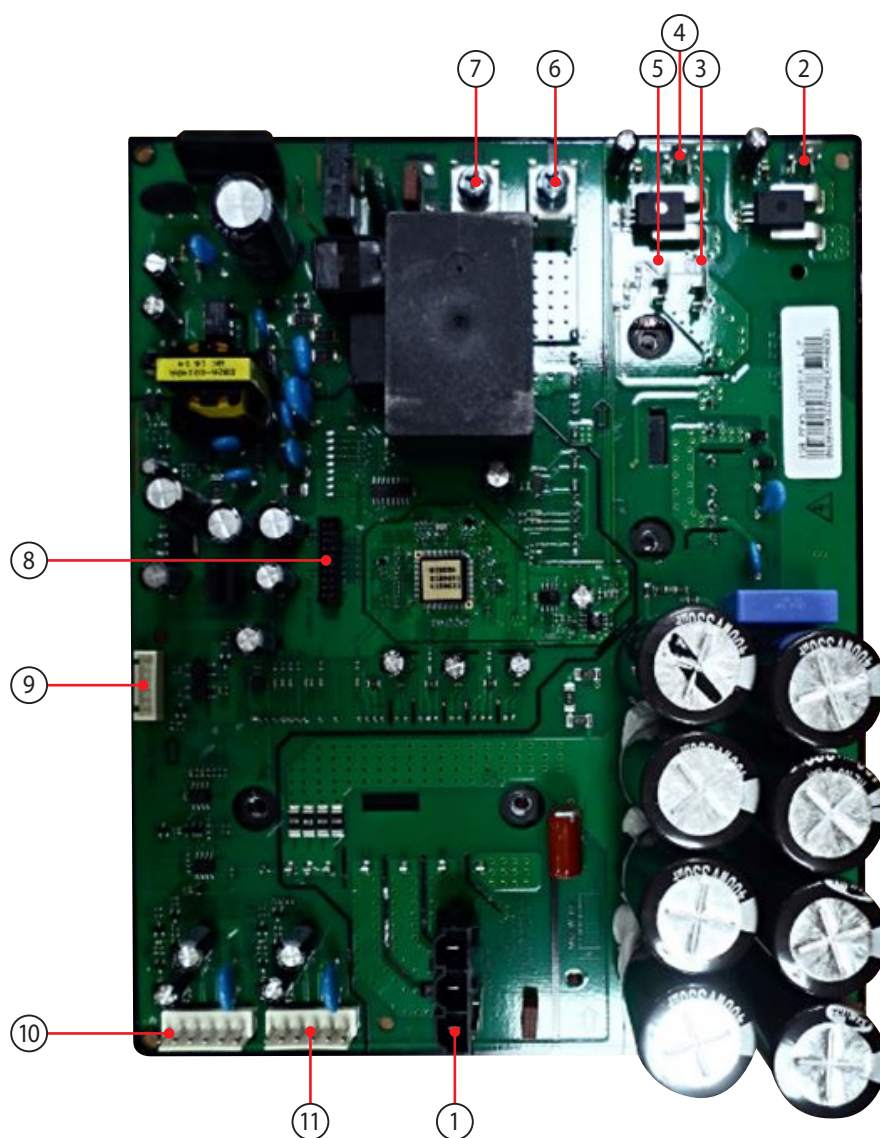

This Document can not be used without Samsung's authorization.

No.	Local	Function	Description
1	CN401	COMP	42819-3213 BLK
2	REACTOR_A2	REACTOR_A	YTR250
3	REACTOR_A1	REACTOR_A	YTR250
4	REACTOR_B2	REACTOR_B	YTR250
5	REACTOR_B1	REACTOR_B	YTR250
6	N	AC POWER	OT-048
7	L	AC POWER	OT-048
8	CN551	DOWNLOAD	YDW200-20 BLK
9	CN351	COMM	SMW250-06 WHT
10	CN901	FAN 1	YW396-06V WHT
11	CN911	FAN 2	YW396-06V WHT

**INVERTER PCB**  
(AE080/090/120/160RX\*\*GG)

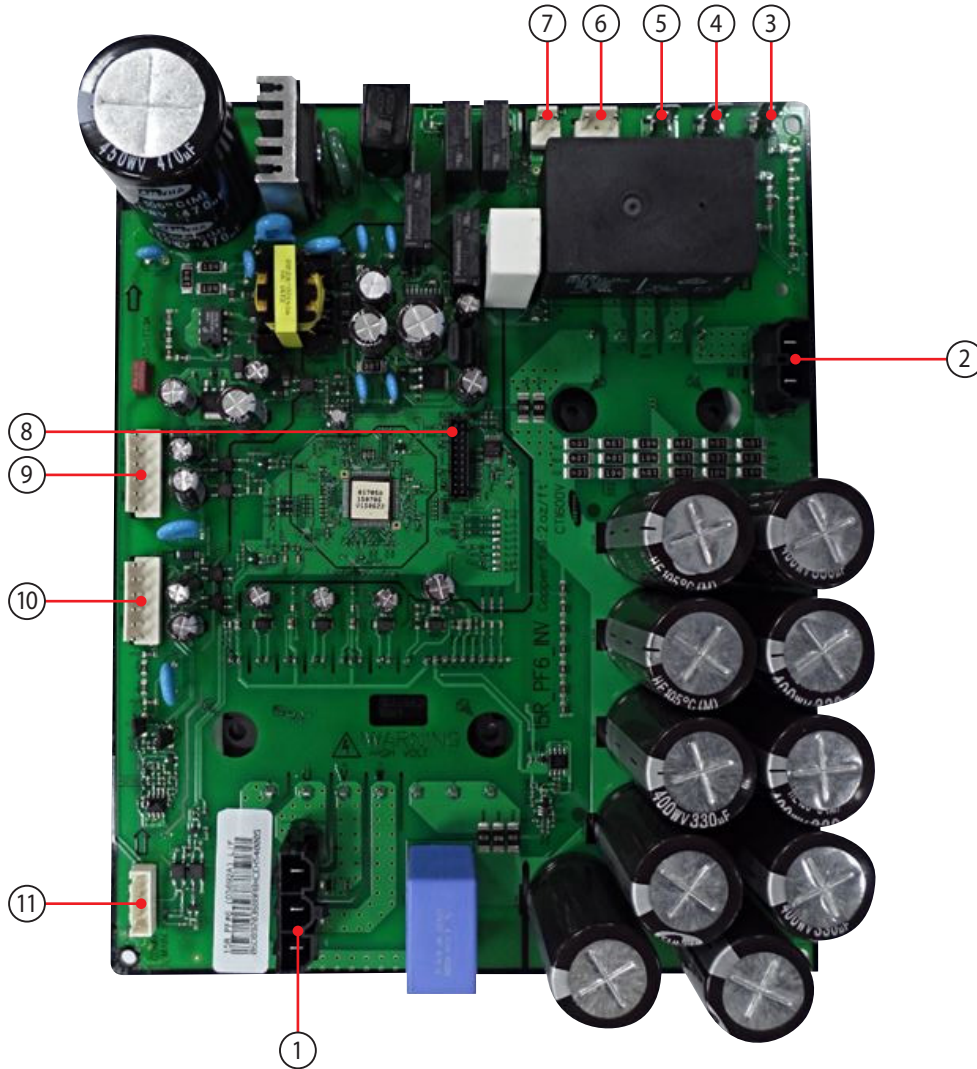

This Document can not be used without Samsung's authorization.

No.	Local	Function	Description
1	CN400	COMP	42819-3213 BLK
2	CN101	REACTOR	HLW1005-02 BLK
3	R	AC POWER	YTR250
4	S	AC POWER	YTR250
5	T	AC POWER	YTR250
6	CN150	AC POWER	YW396-03AV WHT
7	CN151	HIGH PRESSURE SWITCH	YW396-02V WHT
8	CN551	DOWNLOAD	YDW200-20 BLK
9	CN901	FAN 2	YW396-06V WHT
10	CN900	FAN 1	YW396-06V WHT
11	CN351	COMM	SMW250-06 WHT

## EMI PCB (AE090/120/160RX\*\*EG)

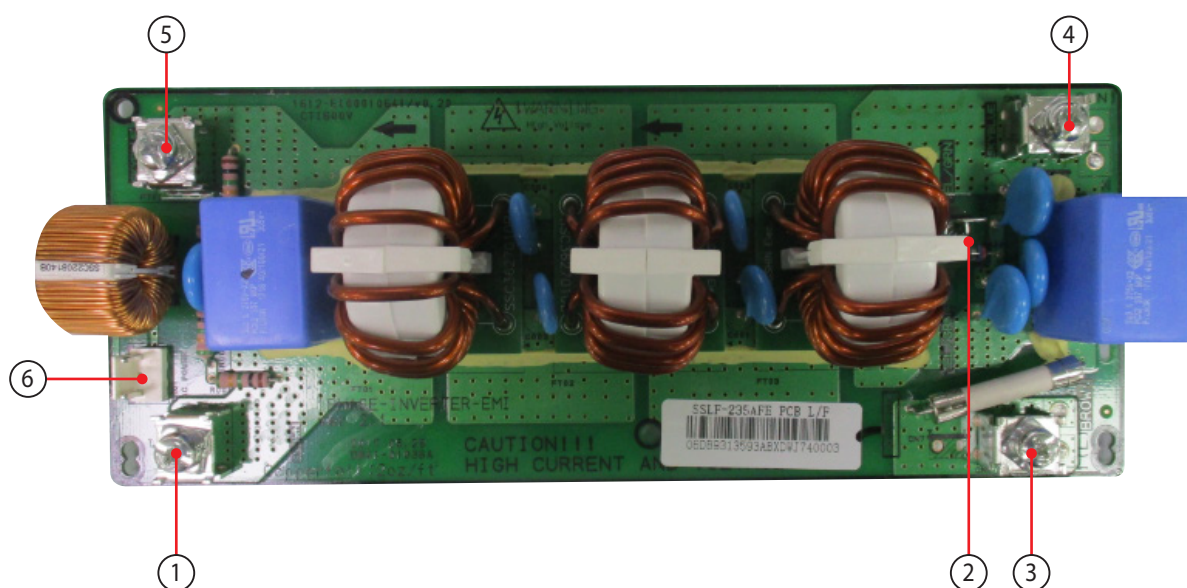

This Document can not be used without Samsung's authorization.

No.	Local	Function	Description
1	L1	AC POWER	OT-048
2	CN8	EARTH	YTR250
3	CN4	AC POWER L	OT-048
4	CN5	AC POWER N	OT-048
5	N1	AC POWER	OT-048
6	CN01	AC POWER	YW396-03AV WHT



**EMI PCB**  
(AE080/090/120/160RX\*\*GG)

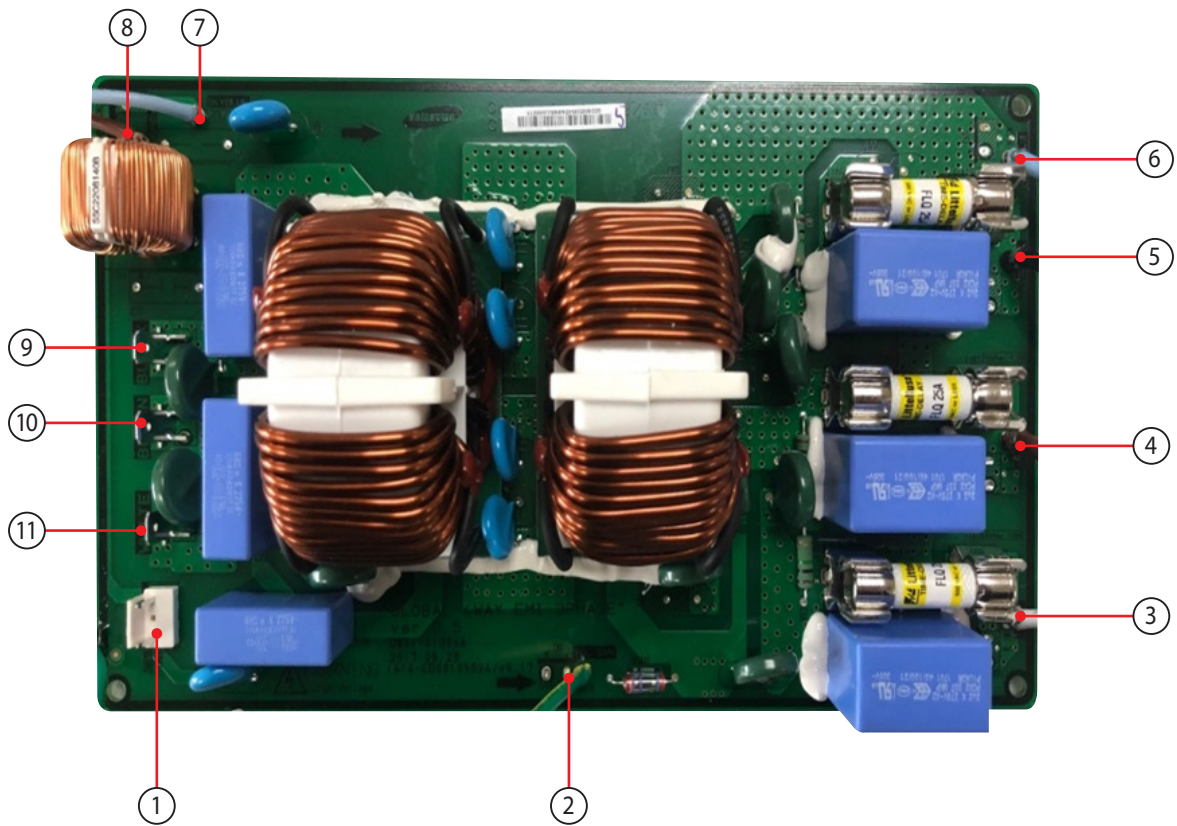

This Document can not be used without Samsung's authorization.

No.	Local	Function	Description
1	CN01	AC POWER	YW396-03AV WHT
2	EARTH	EARTH	YEL/GRN WIRE
3	R-IN	AC POWER	WHT WIRE
4	S-IN	AC POWER	BRN WIRE
5	T-IN	AC POWER	BLK WIRE
6	N-IN	AC POWER	SKY/BLU WIRE
7	N-INV	AC POWER	SKY/BLU WIRE
8	T-INV	AC POWER	BRN WIRE
9	T-OUT	AC POWER	YTR250
10	S-OUT	AC POWER	YTR250
11	R-OUT	AC POWER	YTR250

## SUB-HEATER PCB

(AE080/090/120/160RX\*\*\*\*)

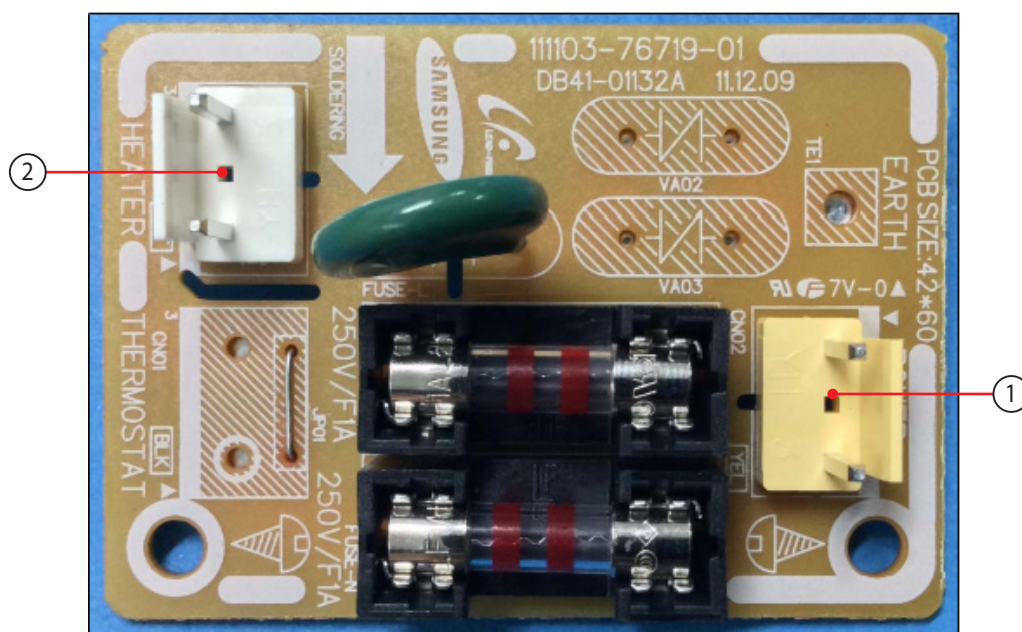

This Document can not be used without Samsung's authorization.

No.	Local	Function	Description
1	CN02	POWER	YW396-03AV YEL
2	CN03	HEATER	YW396-03AV WHT



**INVERTER PCB**  
(AE040/050/060RX\*\*\*\*)

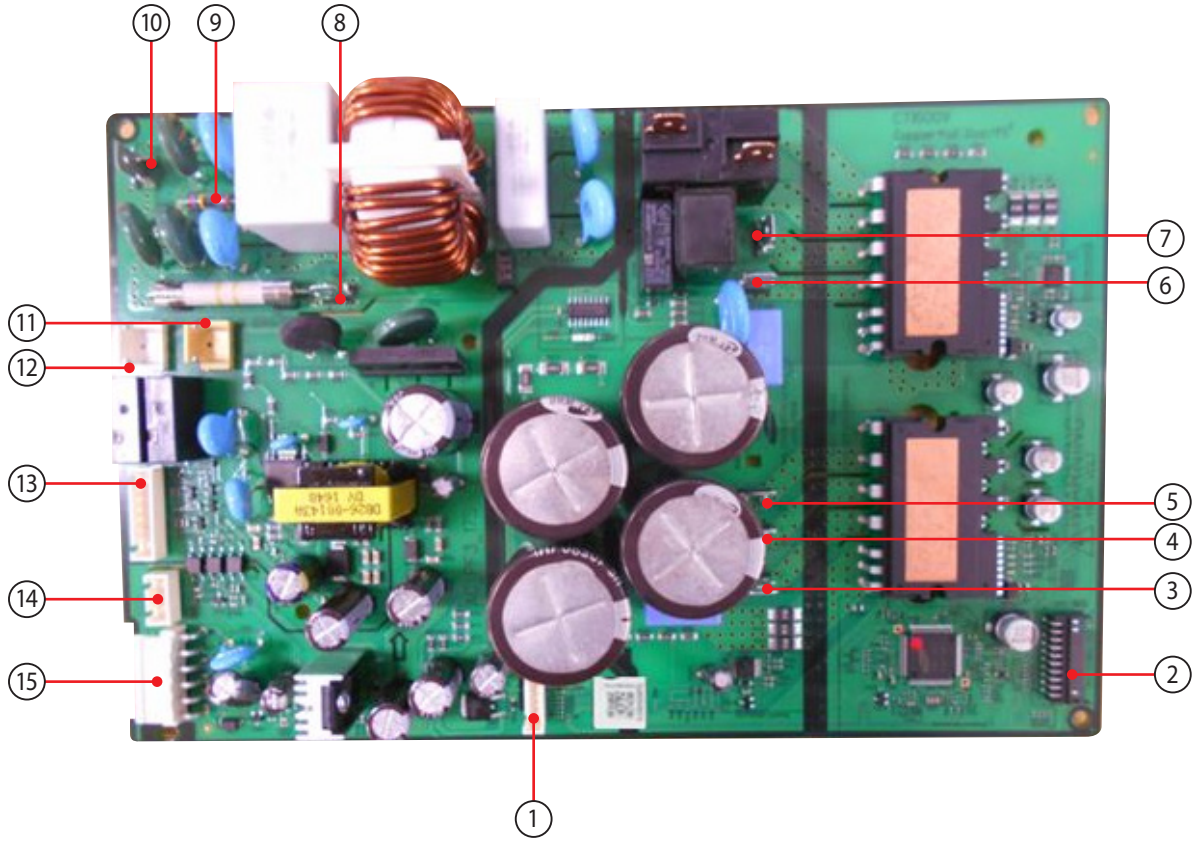

This Document can not be used without Samsung's authorization.

No.	Local	Function	Description
1	CN581	ECO-COMM	SMW200-07 WHT
2	CN551	DOWNLOAD	YDAW200-20 BLK
3	CN401	COMP U	YTR250
4	CN402	COMP V	YTR250
5	CN403	COMP W	YTR250
6	CN051	REACTOR	YTR250
7	CN052	REACTOR	YTR250
8	CN002	AC POWER L	YTR250
9	CN003	EARTH	GP881205
10	CN001	AC POWER N	YTR250
11	CN241	HOT GAS	YW396-03AV YEL
12	CN030	4WAY/AC POWER	YW396-03AV WHT
13	CNP351	MAIN-COMM	SMW250-08 WHT
14	CN571	ECO-DOWNLOAD	SMW250-04 WHT
15	CNP901	BLDC FAN	YAW396-06V WHT

**MAIN PCB**  
(AE040/050/060RX\*\*\*\*)

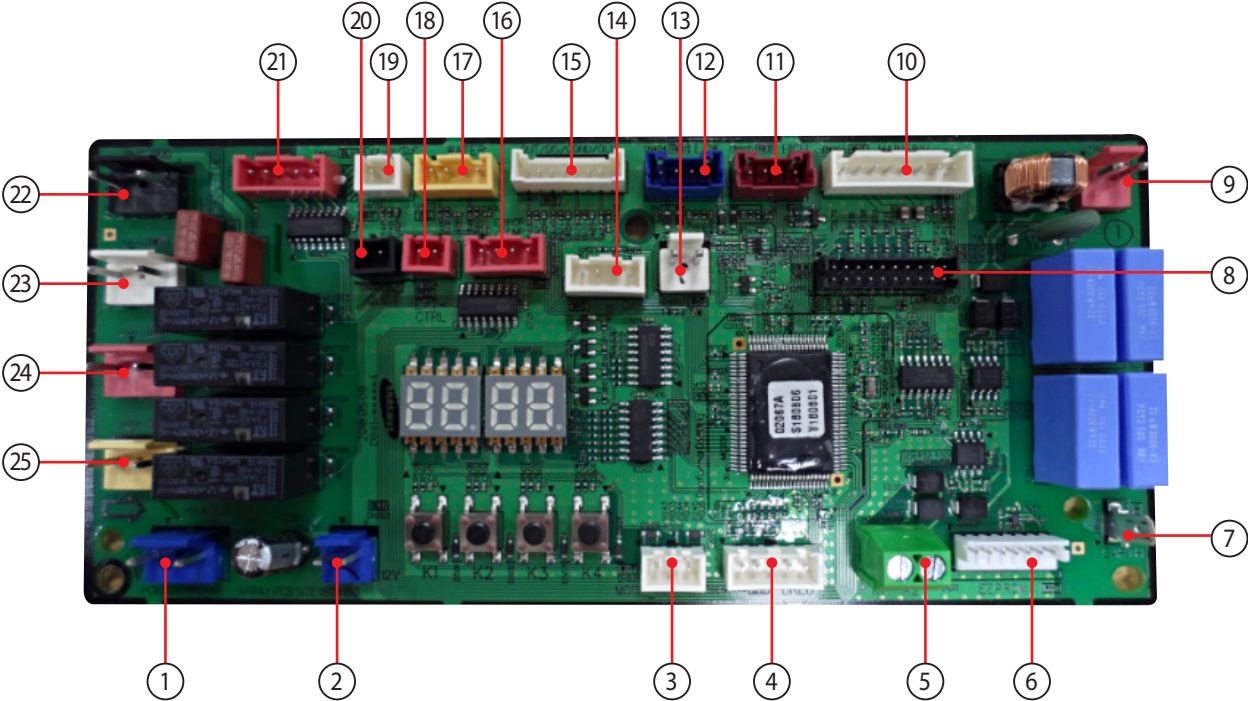

This Document can not be used without Samsung's authorization.

No.	Local	Function	Description
1	CN705	HEATER	YW396-03AV BLU
2	CN303	DC12V	YW396-02V BLU
3	CN501	MODE SELECTOR	SMW250-03 WHT
4	CN002	DRED	SMW250-04 WHT
5	CN302	R1/R2	AKZ350 GRN
6	CN202	EEPROM	B7P-MQ WHT
7	CN305	EARTH	GP881205
8	CN201	DOWNLOAD	YDW200-20 BLK
9	CN301	F1-F2 COMM	YW396-02V RED
10	CN203	MAIN-INV COMM	SMW250-08 WHT
11	CN405	HIGH PRESSURE SENSOR	B04B-XARK-1 RED
12	CN404	LOW PRESSURE SENSOR	B04B-XAEK-1 BLU
13	CN003	HIGH PRESS SWITCH	YW396-02V WHT
14	CN806	R32 GAS SENSOR	SMW250-04 WHT
15	CN401	OUT TEMP/DISCHARGE/COND/OLP	SMW200-08 WHT
16	CN805	ERROR/COMP CHECK	SMW250-04 RED
17	CN402	WATER-IN/WATER-OUT	SMW250-04 YEL
18	CN804	EXTERNAL CONTROL	SMW250-02 RED
19	CN403	EVA-IN/SUCTION	SMW250-02 WHT
20	CN001	QUIET SWITCH	SMW250-02 BLK
21	CN801	EEV	SMW250-05 RED
22	CN701	AC POWER	YW396-03AV BLK
23	CN702	4WAY VALVE	YW396-03AV WHT
24	CN703	HOT GAS	YW396-03AV RED
25	CN704	AC LOAD	YW396-03AV YEL

# 6. Wiring Diagram

## 6-1 Hydro unit

### 6-1-1 3Phase Model

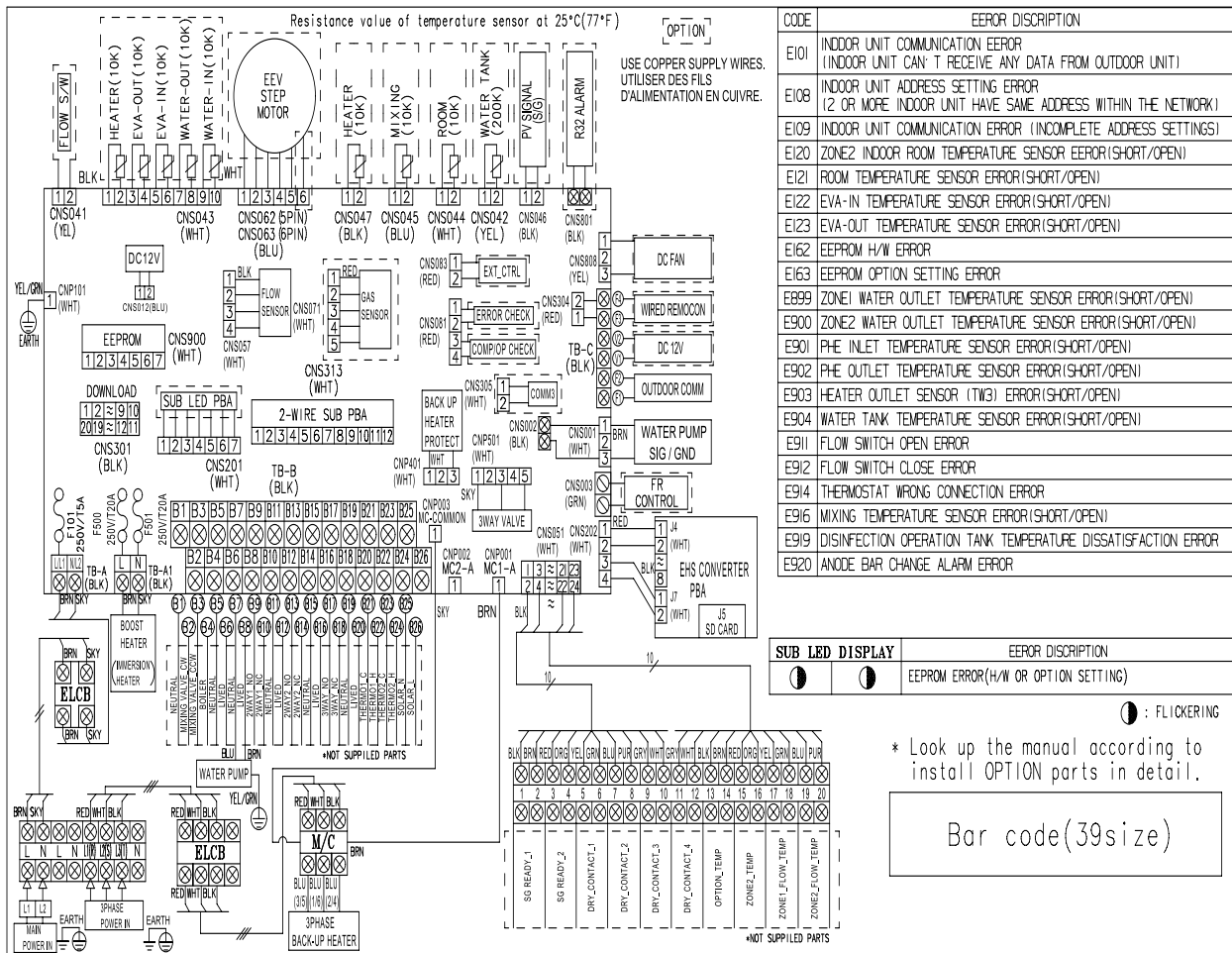

This Document can not be used without Samsung's authorization.

### 6-1-2 1Phase Model

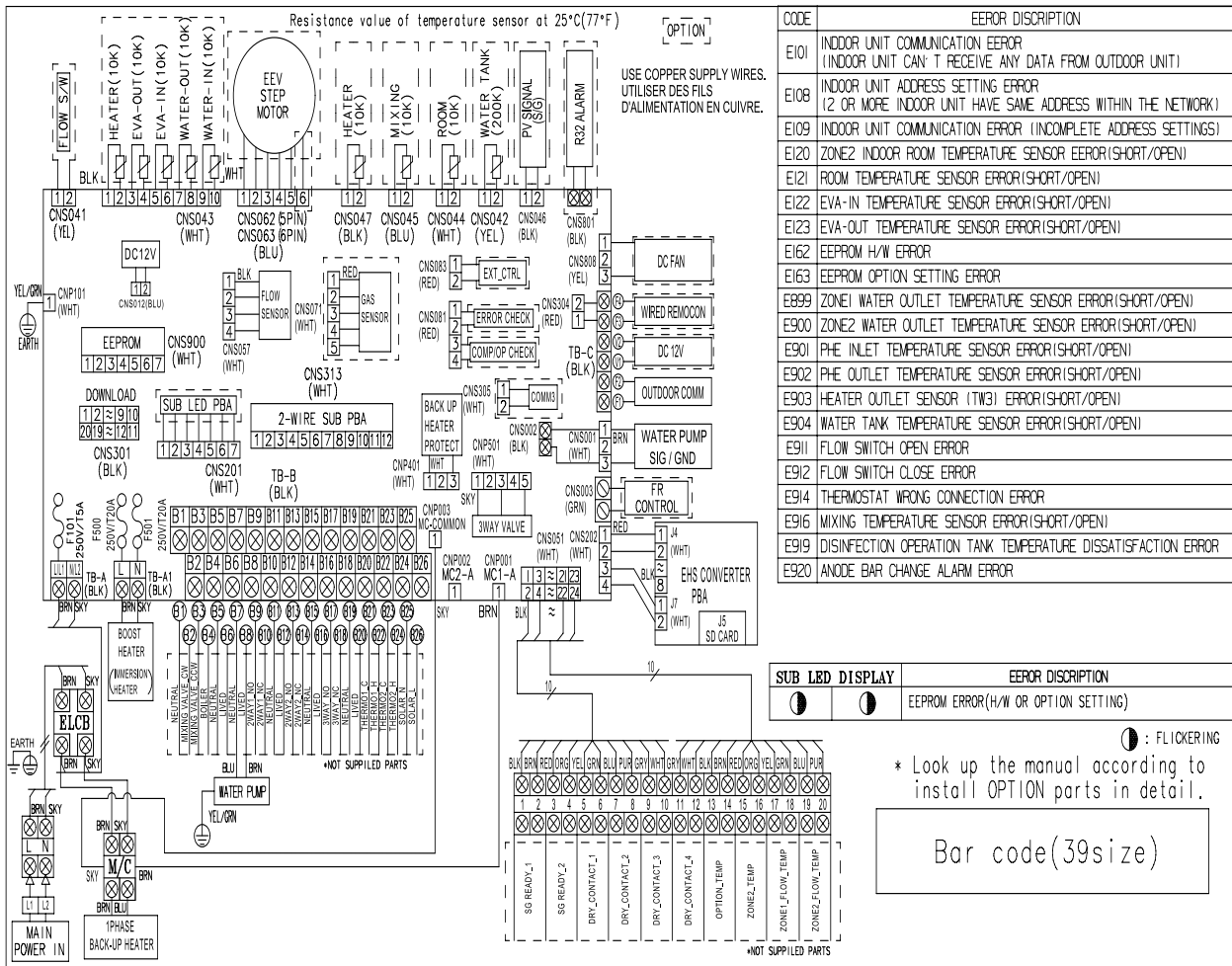

This Document can not be used without Samsung's authorization.

# 6-2 Outdoor Unit

3Phase (AE080/090/120/160/RX\*\*GG)

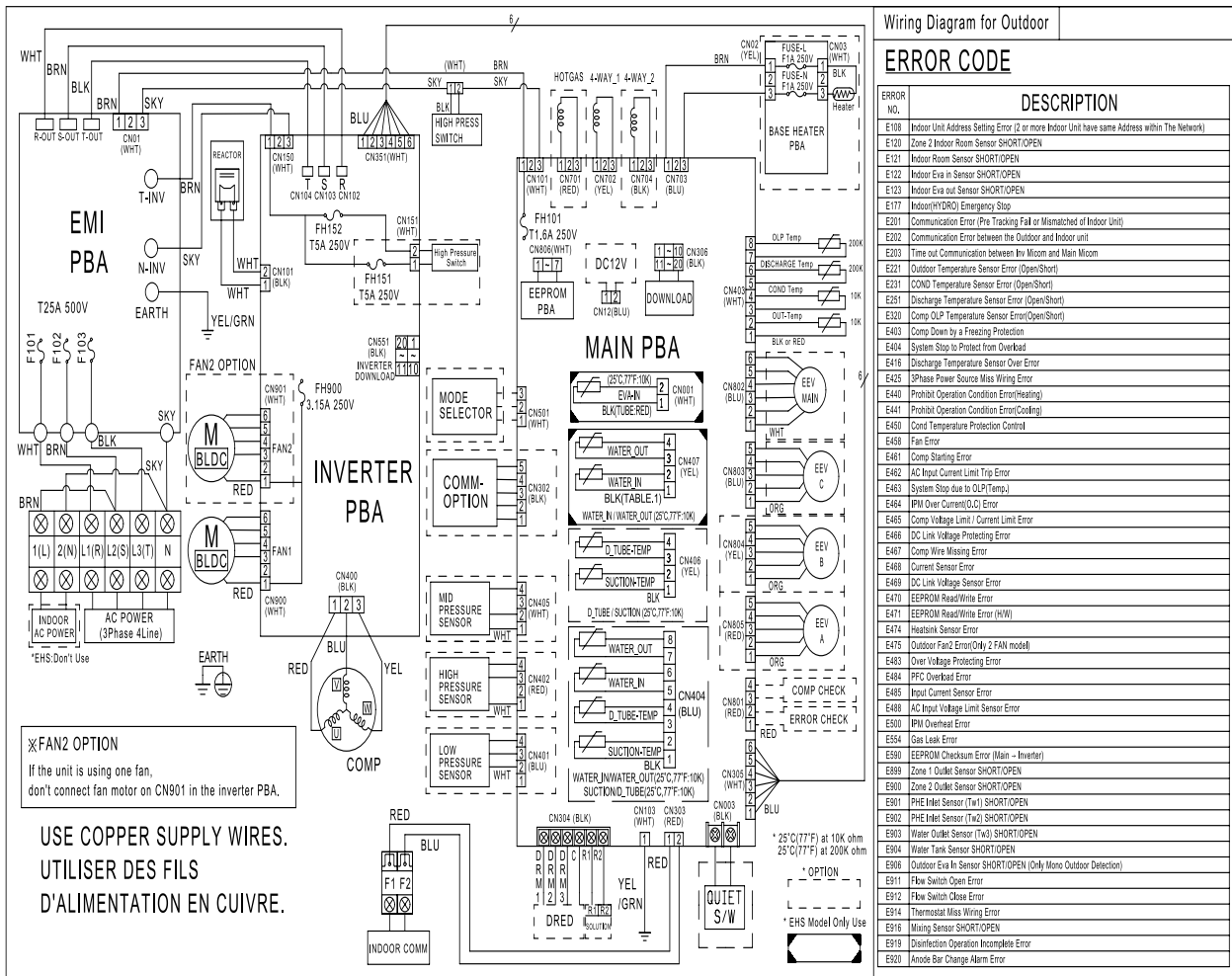

This Document can not be used without Samsung's authorization.



**1Phase (AE090/120/160/RX\*\*EG)**

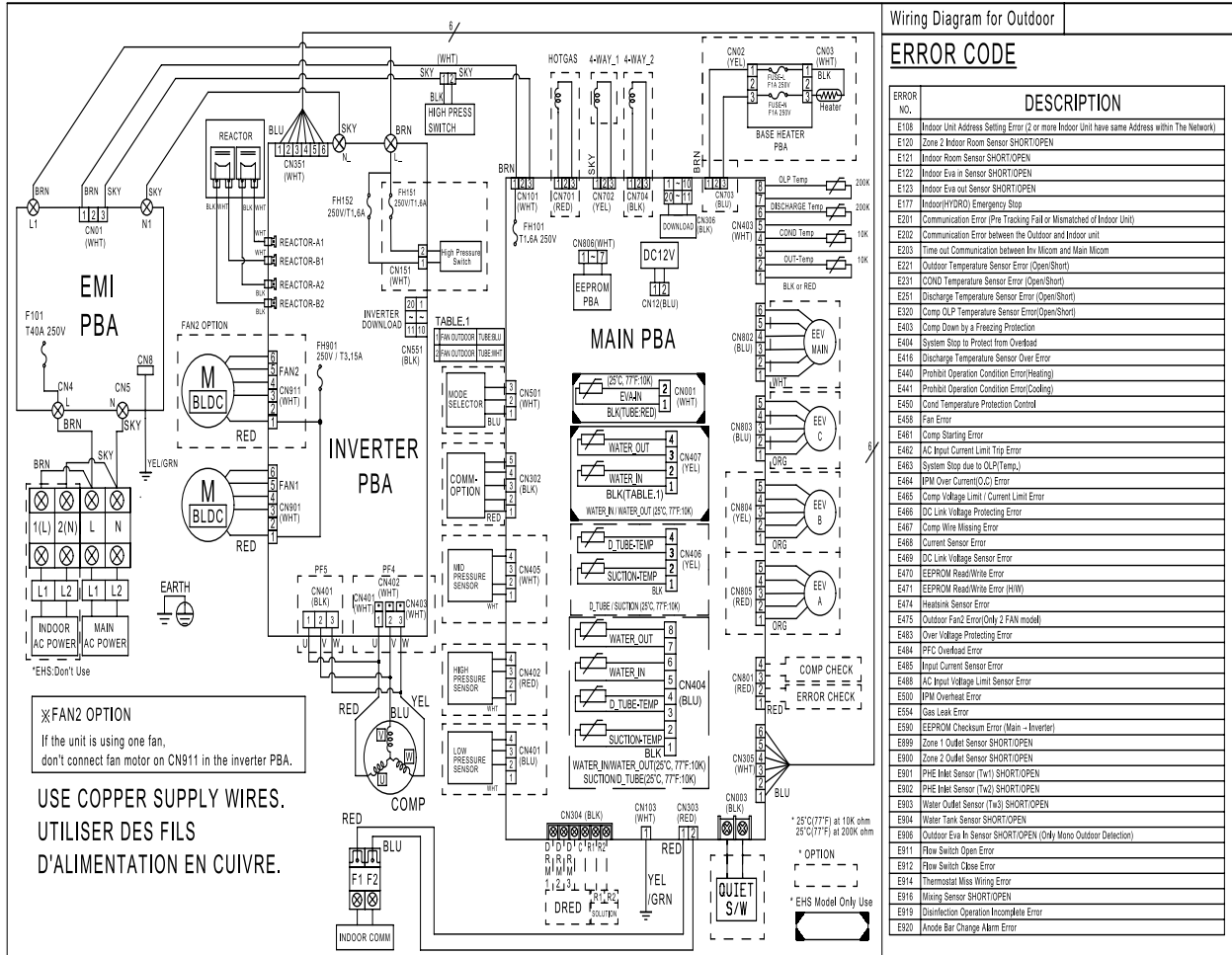

This Document can not be used without Samsung's authorization.



1Phase (AE040/050/060RX\*\*\*\*)

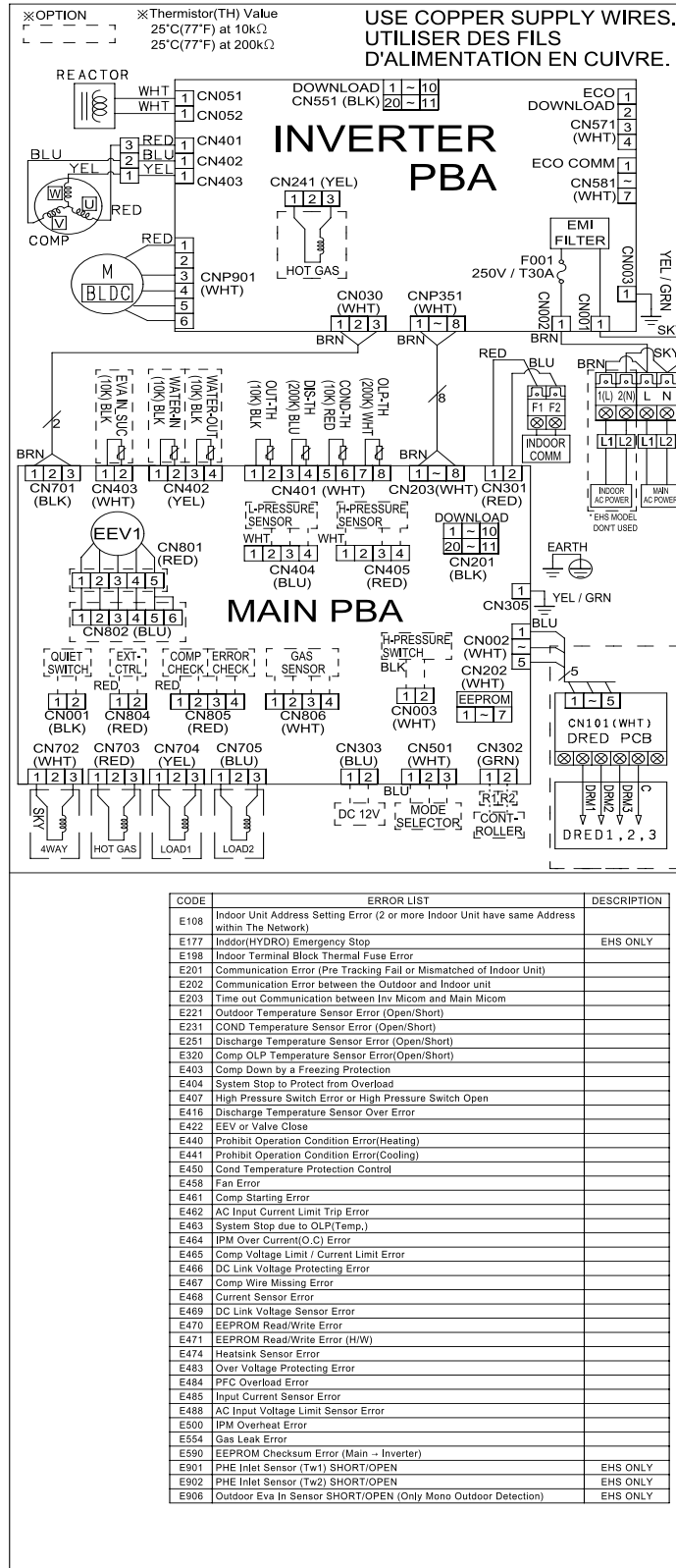

This Document can not be used without Samsung's authorization.

# 7. Reference Sheet

## 7-1 Index for Model Name

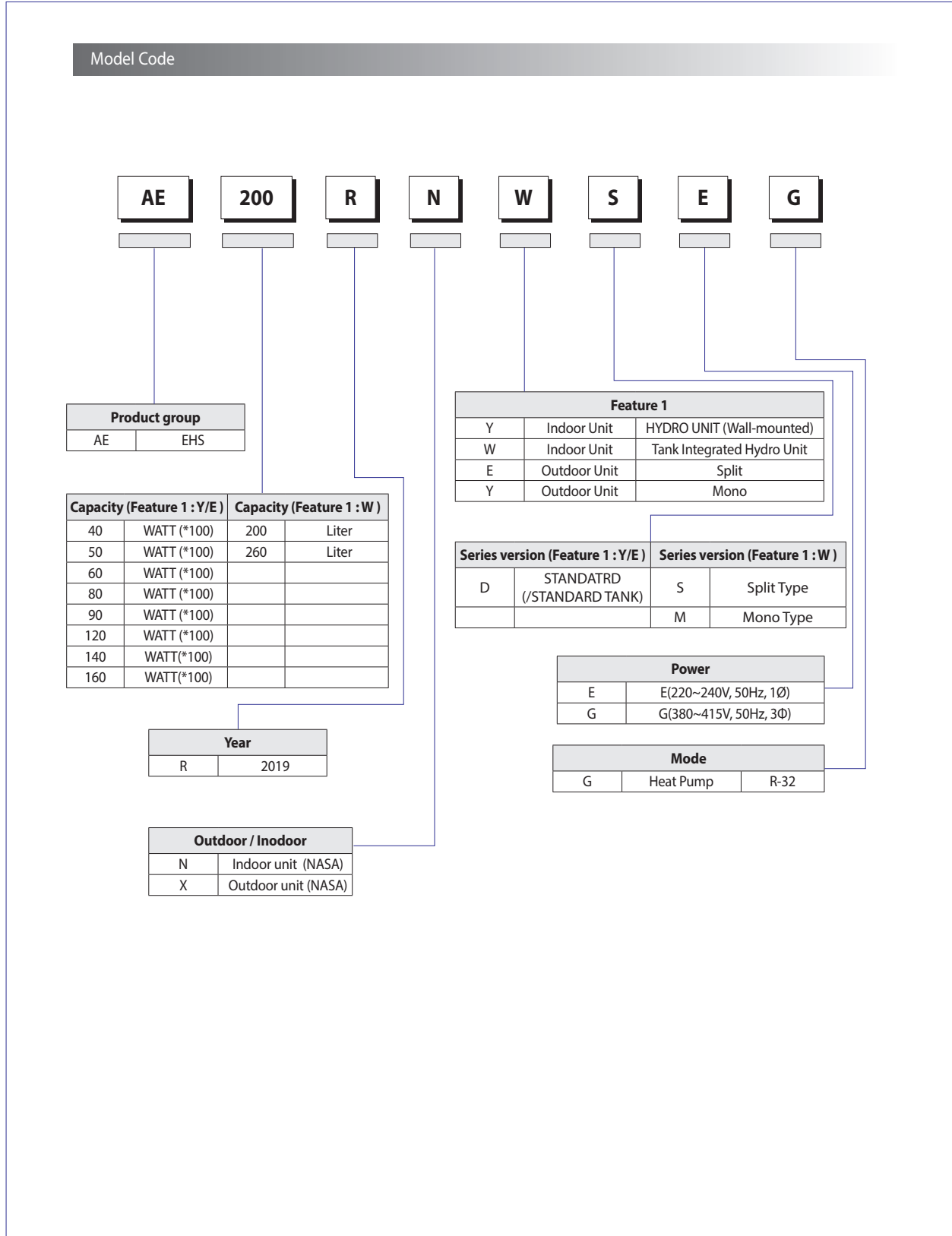

## 7-2 Tank intergrated hydro unit(SPLIT)

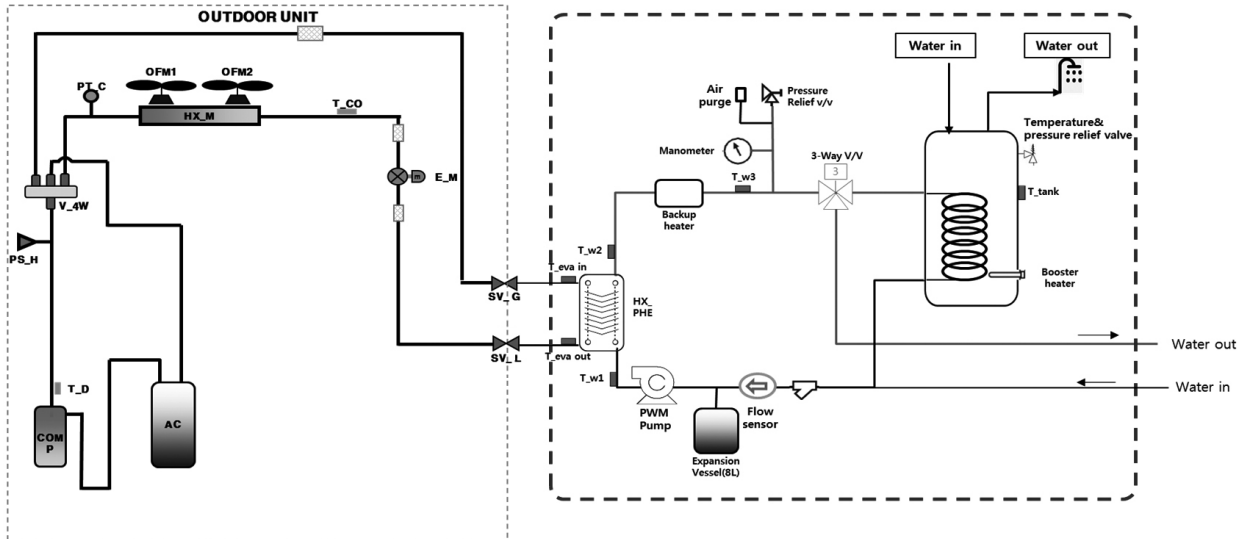

Part	Description
T_w1	Water Inlet temp sensor
T_w2	Water PHX Outlet temp sensor
T_w3	Water Outlet temp sensor
T_eva in	Eva In temp sensor
T_eva out	Eva Out temp sensor
T_tank	Water tank temp sensor
T_D	Discharge temp sensor
PS_H	High pressure switch
V_4W	4Way valve
PT_C	Charging port
HX_M	Outdoor Heat exchanger
OFM	Outdoor fan motor
T_CO	Condout temp sensor
HX_PHE	Plate heat exchanger
E_M	Main expansion valve

## 7-3 Tank intergrated hydro unit(MONO)

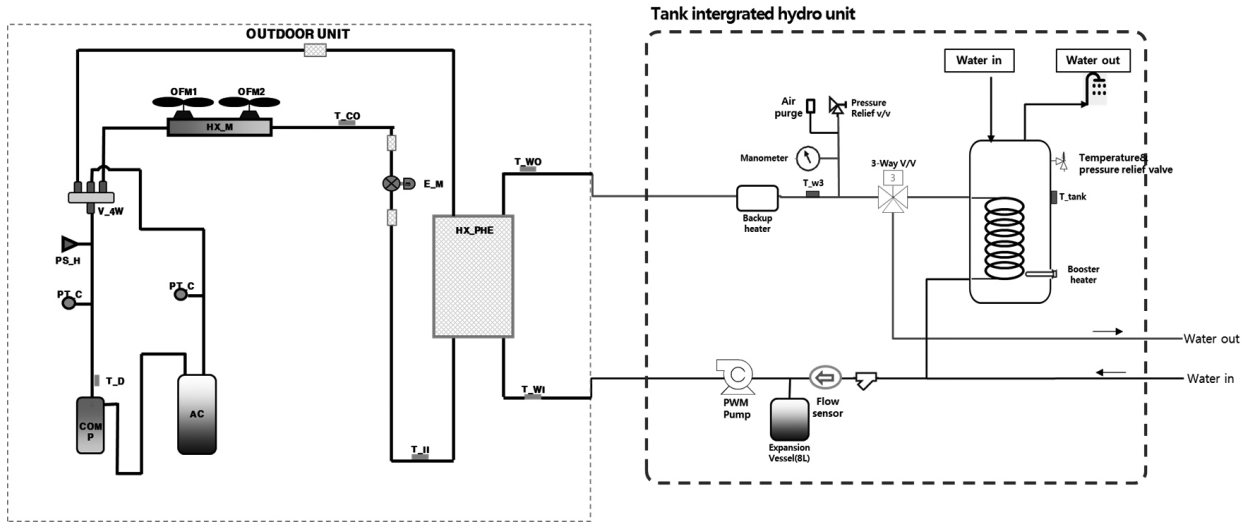

Part	Description
T_WI	Water Inlet temp sensor
T_WO	Water PHX Outlet temp sensor
T_w3	Water Outlet temp sensor
T_II	Eva In temp sensor
T_tank	Water tank temp sensor
T_D	Discharge temp sensor
PS_H	High pressure switch
V_4W	4Way valve
PT_C	Charging port
HX_M	Outdoor Heat exchanger
OFM	Outdoor fan motor
T_CO	Condout temp sensor
HX_PHE	Plate heat exchanger
E_M	Main expansion valve

# 7-4 FSV Data check and update using S-NET Pro2

To check the EHS FSV data the [Update] button must be selected.

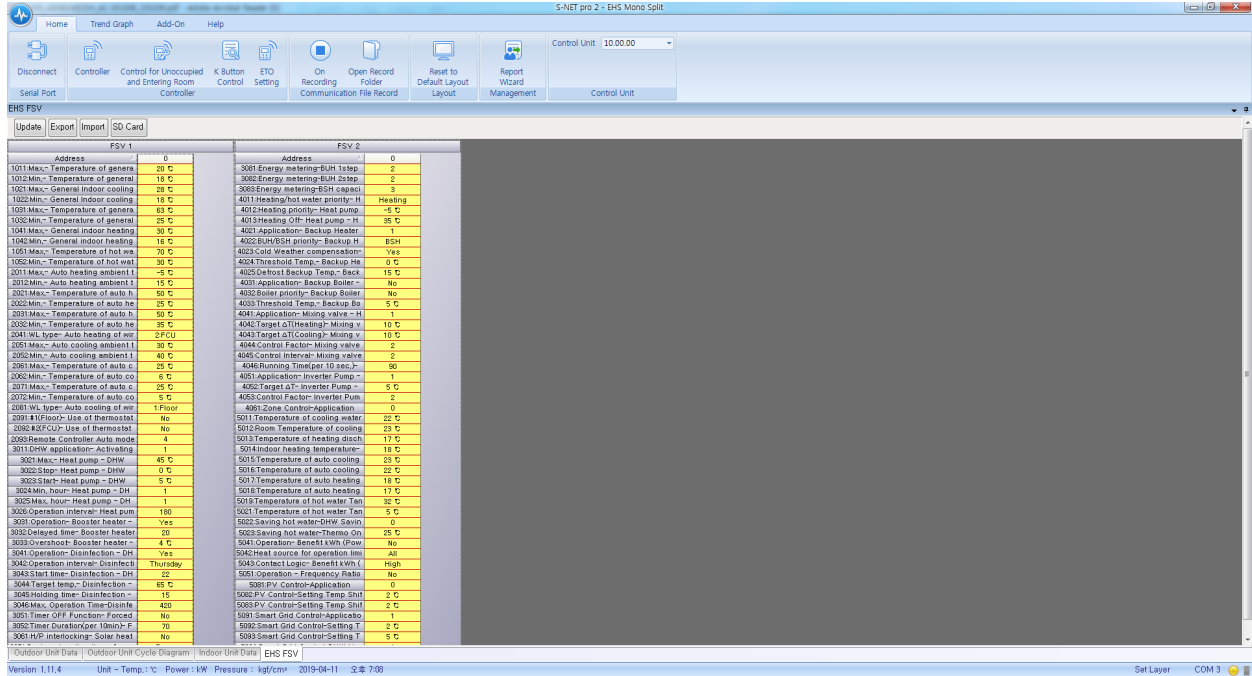

FSV value has been updated, double-click each cell can set the value of the FSV.

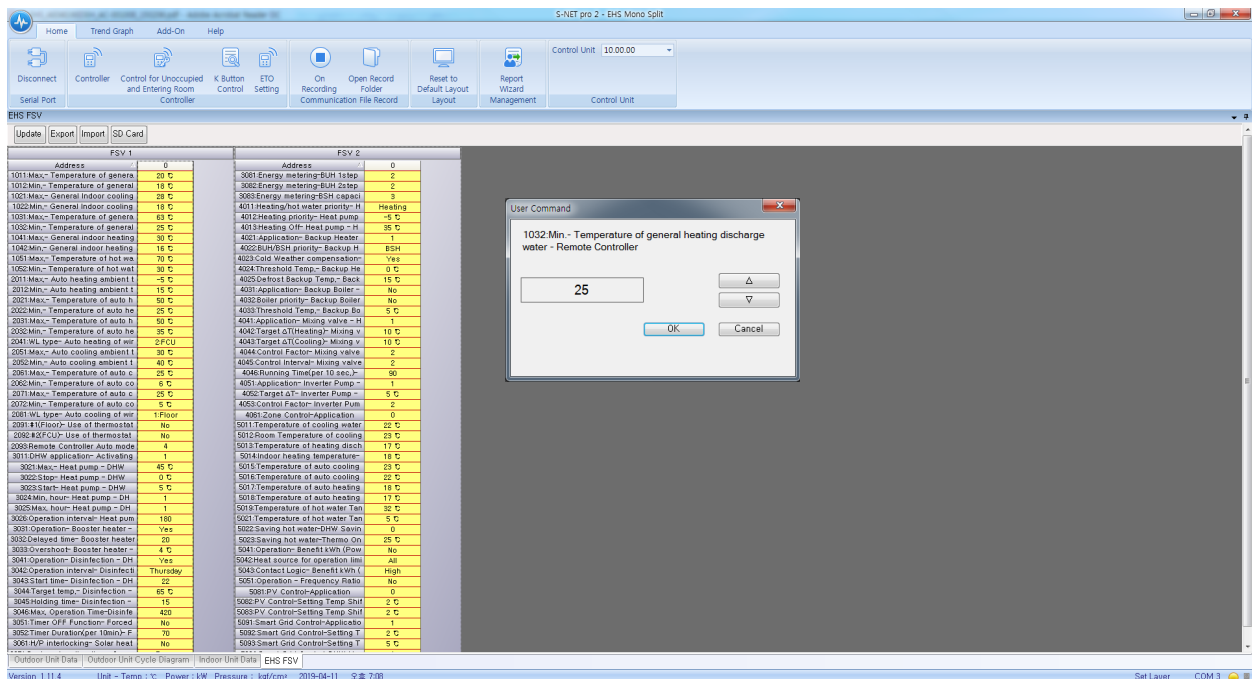

# 7-5 EHS FSV Values Import and Export

The User can now export the existing FSV values into an XML file and update later onto a new unit the saved values.

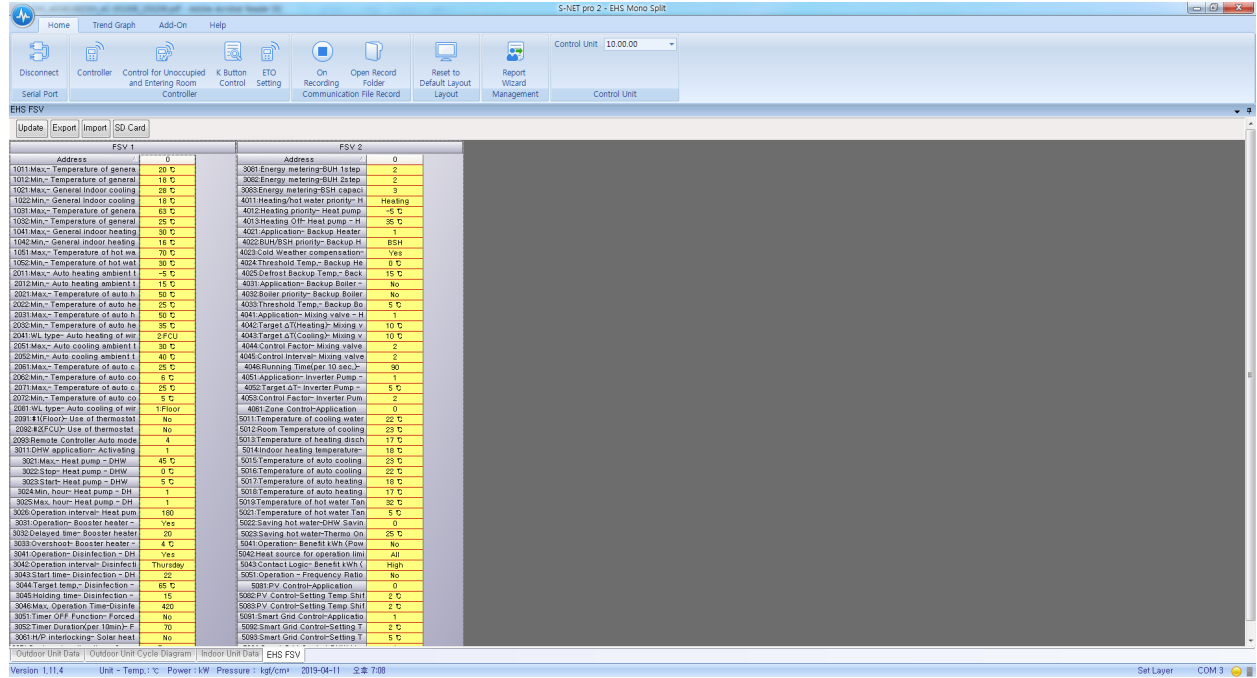

### Export Values:

The existing FSV values can be exported by click on the "Export" button.

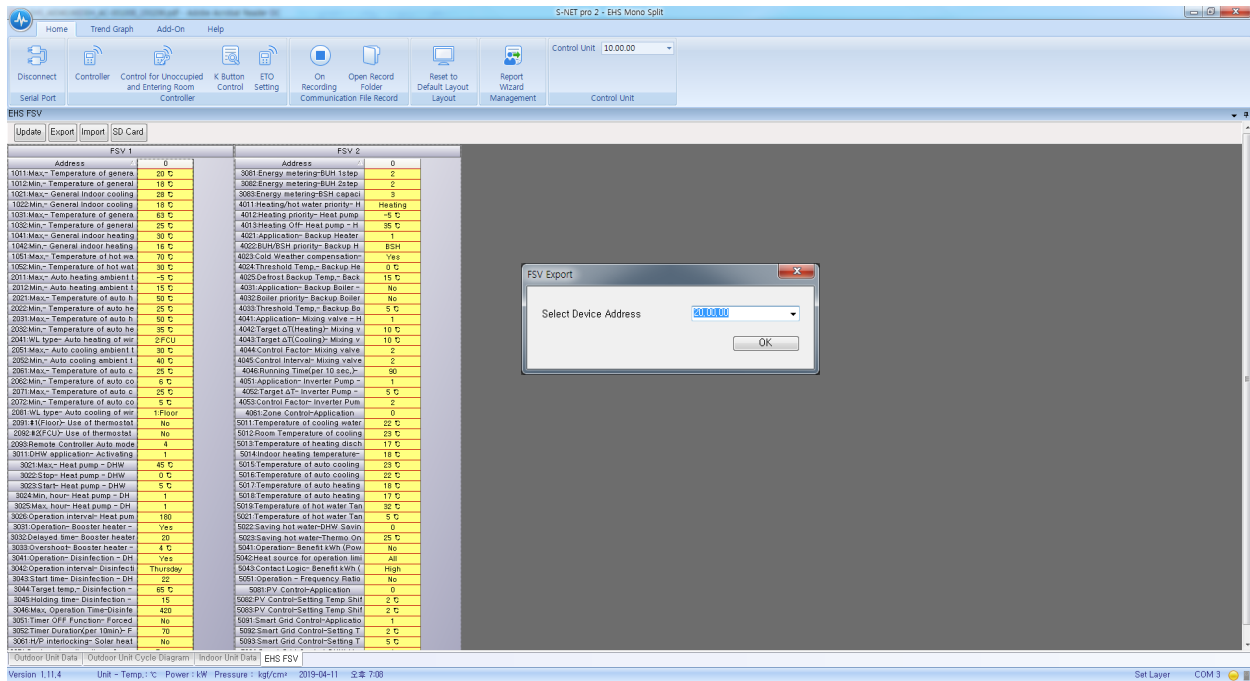

### FSV Import:

The FSV values can be imported by the click on the import button.

The user is prompted to browse and select the XML file for update on the EHS unit selected in the dropdown menu.

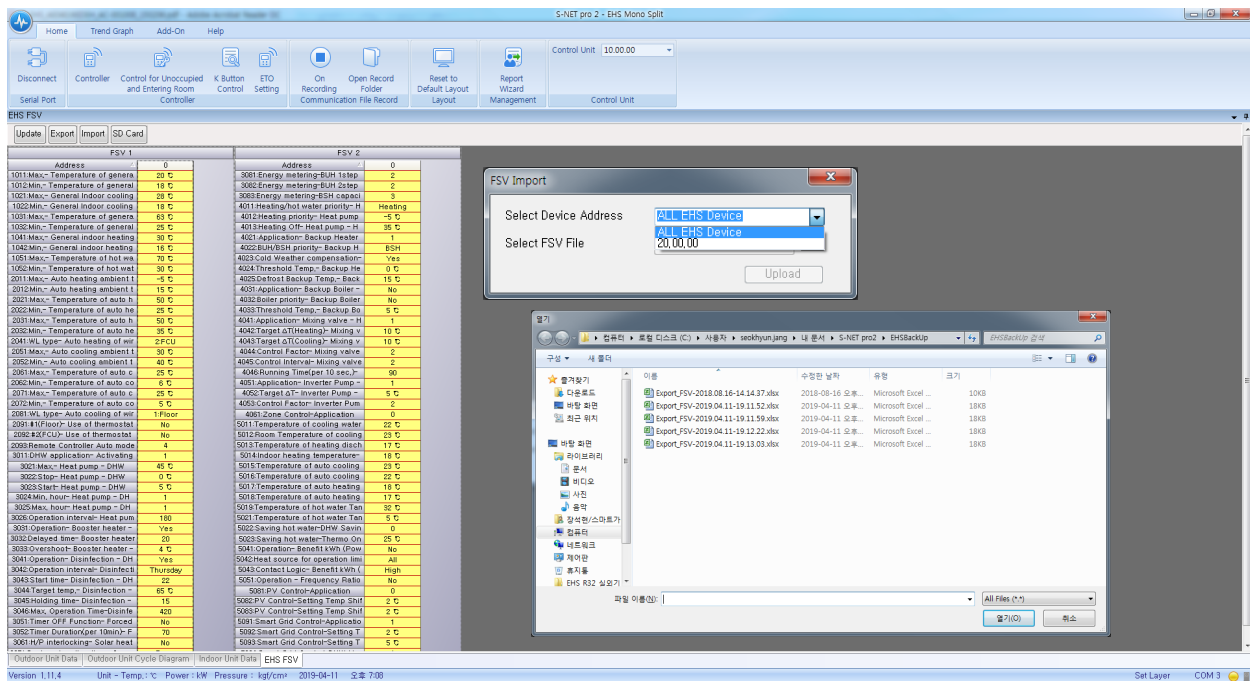



### SD Card

The FSV values can be loaded from SD card or saved to SD card by the click on the import button SD card should be connected in EHS Converter.

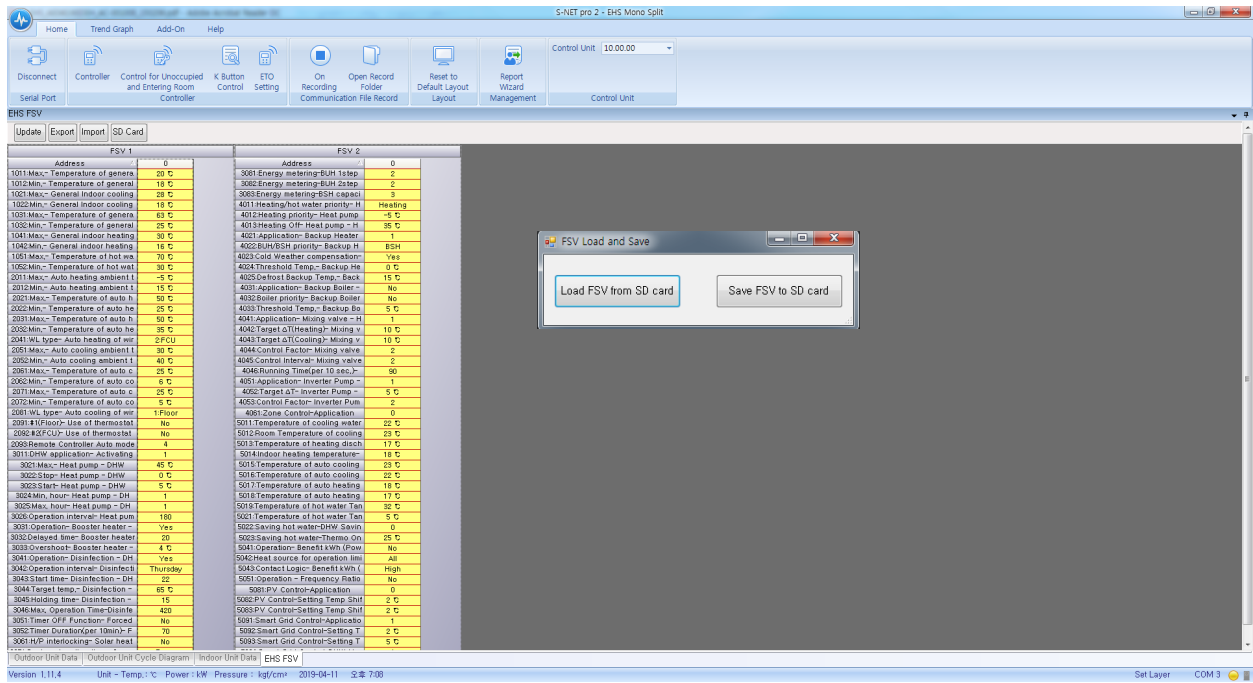

# SAMSUNG

## **GSPN(Global Service Partner Network)**

Area	Web Site
Europe, CIS, Mideast & Africa	<a href="http://gspn1.samsungcsportal.com">gspn1.samsungcsportal.com</a>
Asia	<a href="http://gspn2.samsungcsportal.com">gspn2.samsungcsportal.com</a>
North & Latin America	<a href="http://gspn3.samsungcsportal.com">gspn3.samsungcsportal.com</a>
China	<a href="http://china.samsungportal.com">china.samsungportal.com</a>

This Service Manual is a property of Samsung Electronics Co., Ltd.  
Any unauthorized use of Manual can be punished under applicable  
International and/or domestic law.

© Samsung Electronics Co., Ltd. April 2019.  
Printed in Korea.  
Code No. AC-00242E\_1